

DUGNO NUOLYDIS (prom.) PROJEKTOJAMAS (ESAMAS)	12.5	16.4	7.7	1.2	1.3	2.5
ATSTUMAS (m)	130	239	177	495	351	313
SLAITŲ KOEF., IR DUGNO PLOTIS PROJEKTOJAMAS (ESAMAS)	m=1.5; b=0.80 (esamas 1,0-1,2)					
ATSTUMAS (m)						

PIKETAI	6+70	6+70	6+80	6+90	7+00	7+10	7+20	7+30	7+40	7+50	7+60	7+70	7+80	7+90	8+00	8+10	8+20	8+30	8+40	8+50	8+60	8+70	8+80	8+90	9+00	9+10	9+20	9+30	9+40	9+50	9+60	9+70	9+80	9+90	10+00	10+10	10+20	10+30	10+40	10+50	10+60	10+70	10+80	10+90	11+00	11+10	11+20	11+30	11+40	11+50	11+60	11+70	11+80	11+90	12+00	12+10	12+20	12+30	12+40	12+50	12+60	12+70	12+80	12+90	13+00	13+10	13+20	13+30	13+40	13+50	13+60	13+70	13+80	13+90	14+00	14+10	14+20	14+30	14+40	14+50	14+60	14+70	14+80	14+90	15+00	15+10	15+20	15+30	15+40	15+50	15+60	15+70	15+80	15+90	16+00	16+10	16+20	16+30	16+40	16+50	16+60	16+70	16+80	16+90	17+00	17+10	17+20	17+30	17+40	17+50	17+60	17+70	17+80	17+90	18+00	18+10	18+20	18+30	18+40	18+50	18+60	18+70	18+80	18+90	19+00	19+10	19+20	19+30	19+40	19+50	19+60	19+70	19+80	19+90	20+00	20+10	20+20	20+30	20+40	20+50	20+60	20+70	20+80	20+90	21+00	21+10	21+20	21+30	21+40	21+50	21+60	21+70	21+80	21+90	22+00	22+10	22+20	22+30	22+40	22+50					
ŽEMĖS PAVIRŠIAUS ALTIUDĖS (m)	96.62	96.74	96.76	96.78	96.80	96.82	96.84	96.86	96.88	96.90	96.92	96.94	96.96	96.98	97.00	97.02	97.04	97.06	97.08	97.10	97.12	97.14	97.16	97.18	97.20	97.22	97.24	97.26	97.28	97.30	97.32	97.34	97.36	97.38	97.40	97.42	97.44	97.46	97.48	97.50	97.52	97.54	97.56	97.58	97.60	97.62	97.64	97.66	97.68	97.70	97.72	97.74	97.76	97.78	97.80	97.82	97.84	97.86	97.88	97.90	97.92	97.94	97.96	97.98	98.00	98.02	98.04	98.06	98.08	98.10	98.12	98.14	98.16	98.18	98.20	98.22	98.24	98.26	98.28	98.30	98.32	98.34	98.36	98.38	98.40	98.42	98.44	98.46	98.48	98.50	98.52	98.54	98.56	98.58	98.60	98.62	98.64	98.66	98.68	98.70	98.72	98.74	98.76	98.78	98.80	98.82	98.84	98.86	98.88	98.90	98.92	98.94	98.96	98.98	99.00	99.02	99.04	99.06	99.08	99.10	99.12	99.14	99.16	99.18	99.20	99.22	99.24	99.26	99.28	99.30	99.32	99.34	99.36	99.38	99.40	99.42	99.44	99.46	99.48	99.50	99.52	99.54	99.56	99.58	99.60	99.62	99.64	99.66	99.68	99.70	99.72	99.74	99.76	99.78	99.80	99.82	99.84	99.86	99.88	99.90	99.92	99.94	99.96	99.98	100.00
ESAMOS GROIVIO DUGNO ALTIUDĖS (m)	96.62	96.74	96.76	96.78	96.80	96.82	96.84	96.86	96.88	96.90	96.92	96.94	96.96	96.98	97.00	97.02	97.04	97.06	97.08	97.10	97.12	97.14	97.16	97.18	97.20	97.22	97.24	97.26	97.28	97.30	97.32	97.34	97.36	97.38	97.40	97.42	97.44	97.46	97.48	97.50	97.52	97.54	97.56	97.58	97.60	97.62	97.64	97.66	97.68	97.70	97.72	97.74	97.76	97.78	97.80	97.82	97.84	97.86	97.88	97.90	97.92	97.94	97.96	97.98	98.00	98.02	98.04	98.06	98.08	98.10	98.12	98.14	98.16	98.18	98.20	98.22	98.24	98.26	98.28	98.30	98.32	98.34	98.36	98.38	98.40	98.42	98.44	98.46	98.48	98.50	98.52	98.54	98.56	98.58	98.60	98.62	98.64	98.66	98.68	98.70	98.72	98.74	98.76	98.78	98.80	98.82	98.84	98.86	98.88	98.90	98.92	98.94	98.96	98.98	99.00																																																		
PROJEKTOJAMOS GROIVIO DUGNO ALTIUDĖS (m)	96.61	96.74	96.76	96.78	96.80	96.82	96.84	96.86	96.88	96.90	96.92	96.94	96.96	96.98	97.00	97.02	97.04	97.06	97.08	97.10	97.12	97.14	97.16	97.18	97.20	97.22	97.24	97.26	97.28	97.30	97.32	97.34	97.36	97.38	97.40	97.42	97.44	97.46	97.48	97.50	97.52	97.54	97.56	97.58	97.60	97.62	97.64	97.66	97.68	97.70	97.72	97.74	97.76	97.78	97.80	97.82	97.84	97.86	97.88	97.90	97.92	97.94	97.96	97.98	98.00	98.02	98.04	98.06	98.08	98.10	98.12	98.14	98.16	98.18	98.20	98.22	98.24	98.26	98.28	98.30	98.32	98.34	98.36	98.38	98.40	98.42	98.44	98.46	98.48	98.50	98.52	98.54	98.56	98.58	98.60	98.62	98.64	98.66	98.68	98.70	98.72	98.74	98.76	98.78	98.80	98.82	98.84	98.86	98.88	98.90	98.92	98.94	98.96	98.98	99.00																																																		
KASAMŲ SAŃAŠŲ ARBA GRUNTO STORIS (m)	-0.01	-0.02	-0.03	-0.04	-0.05	-0.06	-0.07	-0.08	-0.09	-0.10	-0.11	-0.12	-0.13	-0.14	-0.15	-0.16	-0.17	-0.18	-0.19	-0.20	-0.21	-0.22	-0.23	-0.24	-0.25	-0.26	-0.27	-0.28	-0.29	-0.30	-0.31	-0.32	-0.33	-0.34	-0.35	-0.36	-0.37	-0.38	-0.39	-0.40	-0.41	-0.42	-0.43	-0.44	-0.45	-0.46	-0.47	-0.48	-0.49	-0.50	-0.51	-0.52	-0.53	-0.54	-0.55	-0.56	-0.57	-0.58	-0.59	-0.60	-0.61	-0.62	-0.63	-0.64	-0.65	-0.66	-0.67	-0.68	-0.69	-0.70	-0.71	-0.72	-0.73	-0.74	-0.75	-0.76	-0.77	-0.78	-0.79	-0.80	-0.81	-0.82	-0.83	-0.84	-0.85	-0.86	-0.87	-0.88	-0.89	-0.90	-0.91	-0.92	-0.93	-0.94	-0.95	-0.96	-0.97	-0.98	-0.99	-1.00																																																																	
GRUNTAS	Priemolis																																																																																																																																																																				
SLAITŲ IR DUGNO STIPRINIMAS PROJEKTOJAMAS (ESAMAS)	Šlaitai stabilūs, apaugę žoline augmenija, dugne sąnašos (Nestiprinama)																																																																																																																																																																				
ESAMOS DEFORMACIJOS	Dugne sąnašos ir aukštastiebė žolinė augmenija, krūmai																									Dugne sąnašos ir aukštastiebė žolinė augmenija																																																																																																																																											
PROJEKTOJAMI DARBAI	Pavalyti groivio dugną nuo sąnašų, pašalinti krūmus																																																																																																																																																																				

SUTARTINIAI ŽENKLAI

- Žemės paviršius
- Esamas groivio dugnas
- Projektuojama dugno linija
- Magistralinio dujotiekio apsaugos zona (po 25 m į abi puses nuo vamzdžio ašies)
- Magistralinio dujotiekio pirmosvietovės klasės teritorijos riba (po 200 m į abi puses nuo vamzdžio ašies)
- Groivio valymo darbus po 3 m į abi puses nuo magistralinio dujotiekio vykdyti rankiniu būdu.
- Žočių užrašas:
 - "d110" nurodo rengiamų žiočių diametrą,
 - 5 - žiočių eilės Nr. nuo groivio pradžios,
 - (4) - buvusį žiočių eilės Nr. nuo groivio pradžios,
 - 104,80 - esamo drenažo žiočių altitudė (kai altitudė nenurodyta, tokiu atveju ji nenusatlyta)

PASTABA: Groivio dugną ties tvarkingomis žiotimis ir esamomis pralaidomis po 2m į abi puses valyti rankiniu būdu

Pastaba. Profiliuose nurodyti pamatuoti drenažo žiočių aukščiai gali skirtis nuo rinktųjų dugnų aukščių. Žiotis keisti atsižvelgiant į esamus drenažo rinktųjų dugnų aukščius.

Aukščiai nurodomi LAS aukščių sistemoje.

0	2026		
Laida	Išleidimo data	Laidos statusas: Keitimo priežastis (jei taikoma)	
Kval. patv. dok. Nr.		Lazdijų rajono savivaldybės Avizienių, Krosnos, Šeštojų ir Teičų kadastrinių vietovių dalių melioracijos statinių rekonstrukcija	
S-757-Pm	SPV	A. Gegužis	Laida
			0
LT	Lazdijų rajono savivaldybė		Lapai
			1
		GP - 26 - TDP - 01 - B.2	Laišy
			13

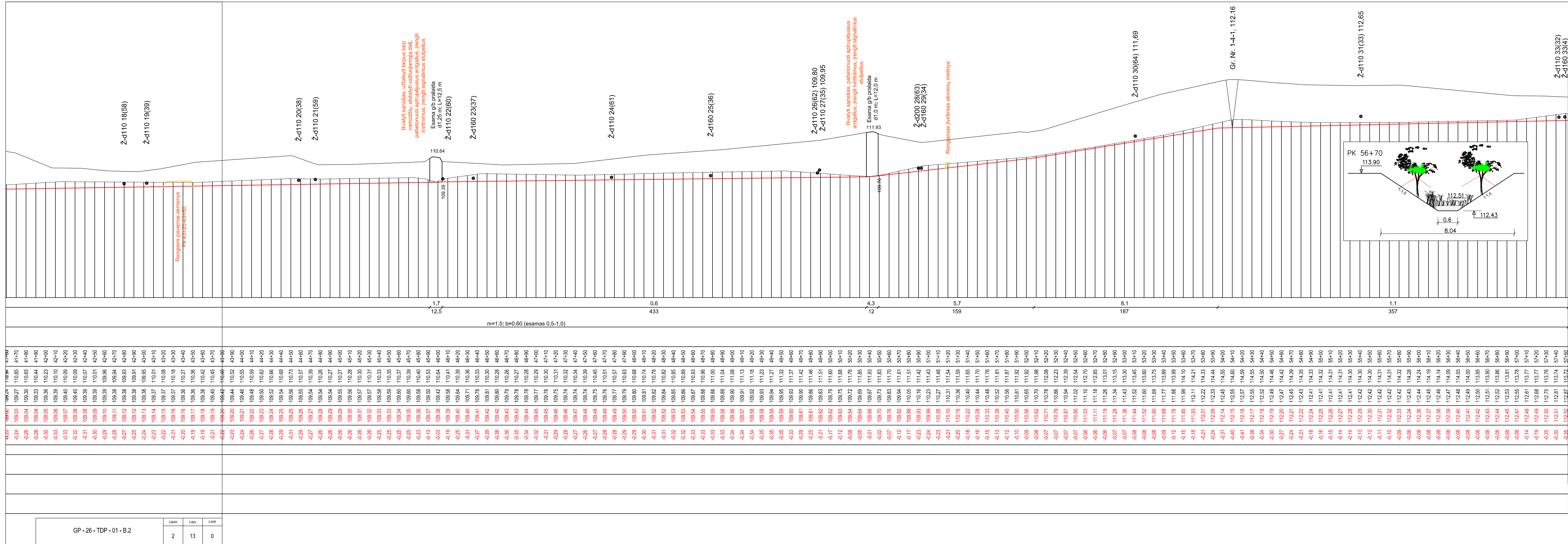

DUGNO NUOLYDIS (prov.) PROJEKTOJAMAS (ESAMAS)
ATSTUMAS (m)
ŠLAITU KOEF., IR DUGNO PLOTIS PROJEKTOJAMAS (ESAMAS)
ATSTUMAS (m)

PIKETAI
ŽEMES PAVIRŠIAUS ALTIUDĖS (m)
ESAMOS GROVIO DUGNO ALTIUDĖS (m)
PROJEKTOJAMOS GROVIO DUGNO ALTIUDĖS (m)
KASAMŲ ŠAŅAŠŲ ARBA GRUNTO STORIS (m)
GRUNTAS
ŠLAITU IR DUGNO STIPRINIMAS PROJEKTOJAMAS (ESAMAS)
ESAMOS DEFORMACIJOS
PROJEKTOJAMI DARBAI

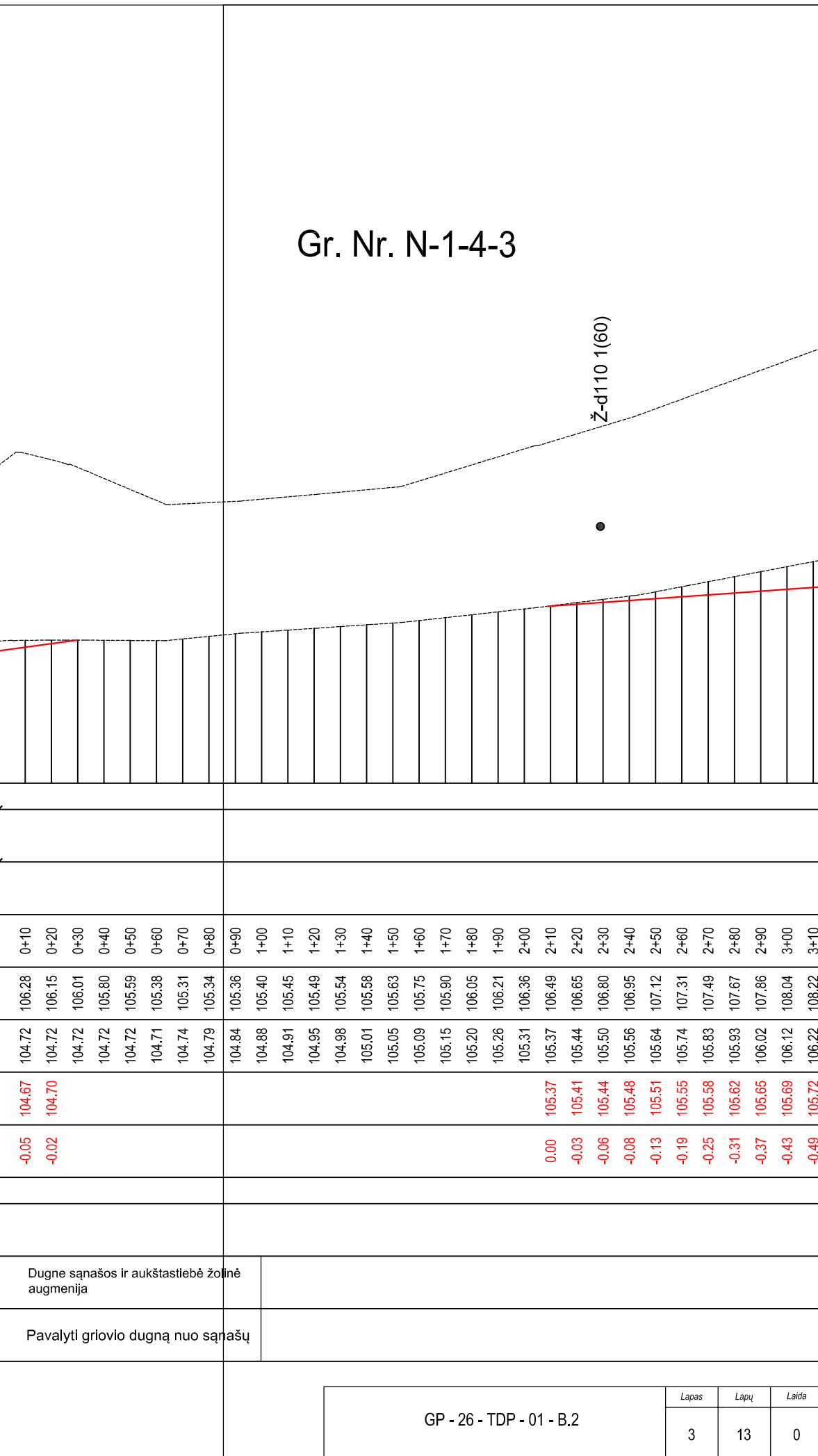

GP - 26 - TDP - 01 - B.2
Lapais
Lapų
Laidų

GP - 26 - TDP - 01 - B.2
Lapais
Lapų
Laidų

Gr. Nr. N-1-4-3

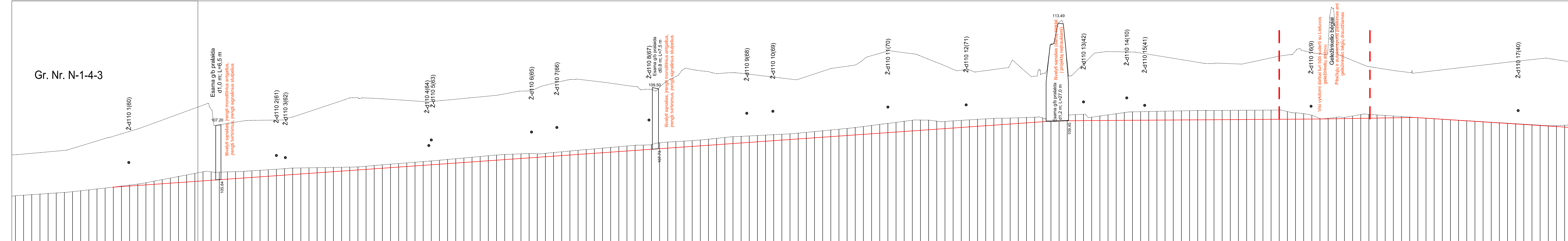

1354	27.5	310	114	191
------	------	-----	-----	-----

104.84	105.36	104.88	105.40	104.91	105.45	104.96	105.50	105.01	105.56	105.05	105.63	105.10	105.67	105.15	105.70	105.20	105.75	105.25	105.80	105.30	105.85	105.35	105.90	105.40	105.95	105.45	106.00	105.50	106.05	105.55	106.10	105.60	106.15	105.65	106.20	105.70	106.25	105.75	106.30	105.80	106.35	105.85	106.40	105.90	106.45	105.95	106.50	106.00	106.55	106.05	106.60	106.10	106.65	106.15	106.70	106.20	106.75	106.25	106.80	106.30	106.85	106.35	106.90	106.40	106.95	106.45	107.00	106.50	107.05	106.55	107.10	106.60	107.15	106.65	107.20	106.70	107.25	106.75	107.30	106.80	107.35	106.85	107.40	106.90	107.45	106.95	107.50	107.00	107.55	107.05	107.60	107.10	107.65	107.15	107.70	107.20	107.75	107.25	107.80	107.30	107.85	107.35	107.90	107.40	107.95	107.45	108.00	107.50	108.05	107.55	108.10	107.60	108.15	107.65	108.20	107.70	108.25	107.75	108.30	107.80	108.35	107.85	108.40	107.90	108.45	107.95	108.50	108.00	108.55	108.05	108.60	108.10	108.65	108.15	108.70	108.20	108.75	108.25	108.80	108.30	108.85	108.35	108.90	108.40	108.95	108.45	109.00	108.50	109.05	108.55	109.10	108.60	109.15	108.65	109.20	108.70	109.25	108.75	109.30	108.80	109.35	108.85	109.40	108.90	109.45	108.95	109.50	109.00	109.55	109.05	109.60	109.10	109.65	109.15	109.70	109.20	109.75	109.25	109.80	109.30	109.85	109.35	109.90	109.40	109.95	109.45	110.00	109.50	110.05	109.55	110.10	109.60	110.15	109.65	110.20	109.70	110.25	109.75	110.30	109.80	110.35	109.85	110.40	109.90	110.45	109.95	110.50	110.00	110.55	110.05	110.60	110.10	110.65	110.15	110.70	110.20	110.75	110.25	110.80	110.30	110.85	110.35	110.90	110.40	110.95	110.45	111.00	110.50	111.05	110.55	111.10	110.60	111.15	110.65	111.20	110.70	111.25	110.75	111.30	110.80	111.35	110.85	111.40	110.90	111.45	110.95	111.50	111.00	111.55	111.05	111.60	111.10	111.65	111.15	111.70	111.20	111.75	111.25	111.80	111.30	111.85	111.35	111.90	111.40	111.95	111.45	12.00	111.50	12.05	111.55	12.10	111.60	12.15	111.65	12.20	111.70	12.25	111.75	12.30	111.80	12.35	111.85	12.40	111.90	12.45	111.95	12.50	112.00	12.55	112.05	12.60	112.10	12.65	112.15	12.70	112.20	12.75	112.25	12.80	112.30	12.85	112.35	12.90	112.40	12.95	112.45	13.00	112.50	13.05	112.55	13.10	112.60	13.15	112.65	13.20	112.70	13.25	112.75	13.30	112.80	13.35	112.85	13.40	112.90	13.45	112.95	13.50	113.00	13.55	113.05	13.60	113.10	13.65	113.15	13.70	113.20	13.75	113.25	13.80	113.30	13.85	113.35	13.90	113.40	13.95	113.45	14.00	113.50	14.05	113.55	14.10	113.60	14.15	113.65	14.20	113.70	14.25	113.75	14.30	113.80	14.35	113.85	14.40	113.90	14.45	113.95	14.50	114.00	14.55	114.05	14.60	114.10	14.65	114.15	14.70	114.20	14.75	114.25	14.80	114.30	14.85	114.35	14.90	114.40	14.95	114.45	15.00	114.50	15.05	114.55	15.10	114.60	15.15	114.65	15.20	114.70	15.25	114.75	15.30	114.80	15.35	114.85	15.40	114.90	15.45	114.95	15.50	115.00	15.55	115.05	15.60	115.10	15.65	115.15	15.70	115.20	15.75	115.25	15.80	115.30	15.85	115.35	15.90	115.40	15.95	115.45	16.00	115.50	16.05	115.55	16.10	115.60	16.15	115.65	16.20	115.70	16.25	115.75	16.30	115.80	16.35	115.85	16.40	115.90	16.45	115.95	16.50	116.00	16.55	116.05	16.60	116.10	16.65	116.15	16.70	116.20	16.75	116.25	16.80	116.30	16.85	116.35	16.90	116.40	16.95	116.45	17.00	116.50	17.05	116.55	17.10	116.60	17.15	116.65	17.20	116.70	17.25	116.75	17.30	116.80	17.35	116.85	17.40	116.90	17.45	116.95	17.50	117.00	17.55	117.05	17.60	117.10	17.65	117.15	17.70	117.20	17.75	117.25	17.80	117.30	17.85	117.35	17.90	117.40	17.95	117.45	18.00	117.50	18.05	117.55	18.10	117.60	18.15	117.65	18.20	117.70	18.25	117.75	18.30	117.80	18.35	117.85	18.40	117.90	18.45	117.95	18.50	118.00	18.55	118.05	18.60	118.10	18.65	118.15	18.70	118.20	18.75	118.25	18.80	118.30	18.85	118.35	18.90	118.40	18.95	118.45	19.00	118.50	19.05	118.55	19.10	118.60	19.15	118.65	19.20	118.70	19.25	118.75	19.30	118.80	19.35	118.85	19.40	118.90	19.45	118.95	19.50	119.00	19.55	119.05	19.60	119.10	19.65	119.15	19.70	119.20	19.75	119.25	19.80	119.30	19.85	119.35	19.90	119.40	19.95	119.45	20.00	119.50	20.05	119.55	20.10	119.60	20.15	119.65	20.20	119.70	20.25	119.75	20.30	119.80	20.35	119.85	20.40	119.90	20.45	119.95	20.50	120.00	20.55	120.05	20.60	120.10	20.65	120.15	20.70	120.20	20.75	120.25	20.80	120.30	20.85	120.35	20.90	120.40	20.95	120.45	21.00	120.50	21.05	120.55	21.10	120.60	21.15	120.65	21.20	120.70	21.25	120.75	21.30	120.80	21.35	120.85	21.40	120.90	21.45	120.95	21.50	121.00	21.55	121.05	21.60	121.10	21.65	121.15	21.70	121.20	21.75	121.25	21.80	121.30	21.85	121.35	21.90	121.40	21.95	121.45	22.00	121.50	22.05	121.55	22.10	121.60	22.15	121.65	22.20	121.70	22.25	121.75	22.30	121.80	22.35	121.85	22.40	121.90	22.45	121.95	22.50	122.00	22.55	122.05	22.60	122.10	22.65	122.15	22.70	122.20	22.75	122.25	22.80	122.30	22.85	122.35	22.90	122.40	22.95	122.45	23.00	122.50	23.05	122.55	23.10	122.60	23.15	122.65	23.20	122.70	23.25	122.75	23.30	122.80	23.35	122.85	23.40	122.90	23.45	122.95	23.50	123.00	23.55	123.05	23.60	123.10	23.65	123.15	23.70	123.20	23.75	123.25	23.80	123.30	23.85	123.35	23.90	123.40	23.95	123.45	24.00	123.50	24.05	123.55	24.10	123.60	24.15	123.65	24.20	123.70	24.25	123.75	24.30	123.80	24.35	123.85	24.40	123.90	24.45	123.95	24.50	124.00	24.55	124.05	24.60	124.10	24.65	124.15	24.70	124.20	24.75	124.25	24.80	124.30	24.85	124.35	24.90	124.40	24.95	124.45	25.00	124.50	25.05	124.55	25.10	124.60	25.15	124.65	25.20	124.70	25.25	124.75	25.30	124.80	25.35	124.85	25.40	124.90	25.45	124.95	25.50	125.00	25.55	125.05	25.60	125.10	25.65	125.15	25.70	125.20	25.75	125.25	25.80	125.30	25.85	125.35	25.90	125.40	25.95	125.45	26.00	125.50	26.05	125.55	26.10	125.60	26.15	125.65	26.20	125.70	26.25	125.75	26.30	125.80	26.35	125.85	26.40	125.90	26.45	125.95	26.50	126.00	26.55	126.05	26.60	126.10	26.65	126.15	26.70	126.20	26.75	126.25	26.80	126.30	26.85	126.35	26.90	126.40	26.95	126.45	27.00	126.50	27.05	126.55	27.10	126.60	27.15	126.65	27.20	126.70	27.25	126.75	27.30	126.80	27.35	126.85	27.40	126.90	27.45	126.95	27.50	127.00	27.55	127.05	27.60	127.10	27.65	127.15	27.70	127.20	27.75	127.25	27.80	127.30	27.85	127.35	27.90	127.40	27.95	127.45	28.00	127.50	28.05	127.55	28.10	127.60	28.15	127.65	28.20	127.70	28.25	127.75	28.30	127.80	28.35	127.85	28.40	127.90	28.45	127.95	28.50	128.00	28.55	128.05	28.60	128.10	28.65	128.15	28.70	128.20	28.75	128.25	28.80	128.30	28.85	128.35	28.90	128.40	28.95	128.45	29.00	128.50	29.05	128.55	29.10	128.60	29.15	128.65	29.20	128.70	29.25	128.75	29.30	128.80	29.35	128.85	29.40	128.90	29.45	128.95	29.50	129.00	29.55	129.05	29.60	129.10	29.65	129.15	29.70	129.20	29.75	129.25	29.80	129.30	29.85	129.35	29.90	129.40	29.95	129.45	30.00	129.50	30.05	129.55	30.10	129.60	30.15	129.65	30.20	129.70	30.25	129.75	30.30	129.80	30.35	129.85	30.40	129.90	30.45	129.95	30.50	130.00	30.55	130.05	30.60	130.10	30.65	130.15	30.70	130.20	30.75	130.25	30.80	130.30	30.85	130.35	30.90	130.40	30.95	130.45	31.00	130.50	31.05	130.55	31.10	130.60	31.15	130.65	31.20	130.70	31.25	130.75	31.30	130.80	31.35	130.85	31.40	130.90	31.45	130.95	31.50	131.00	31.55	131.05	31.60	131.10	31.65	131.15	31.70	131.20	31.75	131.25	31.80	131.30	31.85	131.35	31.90	131.40	31.95	131.45	32.00	131.50	32.05	131.55	32.10	131.60	32.15	131.65	32.20	131.70	32.25	131.75	32.30	131.80	32.35	131.85	32.40	131.90	32.45	131.95	32.50	132.00	32.55	132.05	32.60	132.10	32.65	132.15	32.70	132.20	32.75	132.25	32.80	132.30	32.85	132.35	32.90	132.40	32.95	132.45	33.00	132.50	33.05	132.55	33.10	132.60	33.15	132.65	33.20	132.70	33.25	132.75	33.30	132.80	33.35	132.85	33.40	132.90	33.45	13
--------	--------	--------	--------	--------	--------	--------	--------	--------	--------	--------	--------	--------	--------	--------	--------	--------	--------	--------	--------	--------	--------	--------	--------	--------	--------	--------	--------	--------	--------	--------	--------	--------	--------	--------	--------	--------	--------	--------	--------	--------	--------	--------	--------	--------	--------	--------	--------	--------	--------	--------	--------	--------	--------	--------	--------	--------	--------	--------	--------	--------	--------	--------	--------	--------	--------	--------	--------	--------	--------	--------	--------	--------	--------	--------	--------	--------	--------	--------	--------	--------	--------	--------	--------	--------	--------	--------	--------	--------	--------	--------	--------	--------	--------	--------	--------	--------	--------	--------	--------	--------	--------	--------	--------	--------	--------	--------	--------	--------	--------	--------	--------	--------	--------	--------	--------	--------	--------	--------	--------	--------	--------	--------	--------	--------	--------	--------	--------	--------	--------	--------	--------	--------	--------	--------	--------	--------	--------	--------	--------	--------	--------	--------	--------	--------	--------	--------	--------	--------	--------	--------	--------	--------	--------	--------	--------	--------	--------	--------	--------	--------	--------	--------	--------	--------	--------	--------	--------	--------	--------	--------	--------	--------	--------	--------	--------	--------	--------	--------	--------	--------	--------	--------	--------	--------	--------	--------	--------	--------	--------	--------	--------	--------	--------	--------	--------	--------	--------	--------	--------	--------	--------	--------	--------	--------	--------	--------	--------	--------	--------	--------	--------	--------	--------	--------	--------	--------	--------	--------	--------	--------	--------	--------	--------	--------	--------	--------	--------	--------	--------	--------	--------	--------	--------	--------	--------	--------	--------	--------	--------	--------	--------	--------	--------	--------	--------	--------	--------	--------	--------	--------	--------	--------	--------	--------	--------	--------	--------	--------	--------	--------	--------	--------	--------	--------	--------	--------	-------	--------	-------	--------	-------	--------	-------	--------	-------	--------	-------	--------	-------	--------	-------	--------	-------	--------	-------	--------	-------	--------	-------	--------	-------	--------	-------	--------	-------	--------	-------	--------	-------	--------	-------	--------	-------	--------	-------	--------	-------	--------	-------	--------	-------	--------	-------	--------	-------	--------	-------	--------	-------	--------	-------	--------	-------	--------	-------	--------	-------	--------	-------	--------	-------	--------	-------	--------	-------	--------	-------	--------	-------	--------	-------	--------	-------	--------	-------	--------	-------	--------	-------	--------	-------	--------	-------	--------	-------	--------	-------	--------	-------	--------	-------	--------	-------	--------	-------	--------	-------	--------	-------	--------	-------	--------	-------	--------	-------	--------	-------	--------	-------	--------	-------	--------	-------	--------	-------	--------	-------	--------	-------	--------	-------	--------	-------	--------	-------	--------	-------	--------	-------	--------	-------	--------	-------	--------	-------	--------	-------	--------	-------	--------	-------	--------	-------	--------	-------	--------	-------	--------	-------	--------	-------	--------	-------	--------	-------	--------	-------	--------	-------	--------	-------	--------	-------	--------	-------	--------	-------	--------	-------	--------	-------	--------	-------	--------	-------	--------	-------	--------	-------	--------	-------	--------	-------	--------	-------	--------	-------	--------	-------	--------	-------	--------	-------	--------	-------	--------	-------	--------	-------	--------	-------	--------	-------	--------	-------	--------	-------	--------	-------	--------	-------	--------	-------	--------	-------	--------	-------	--------	-------	--------	-------	--------	-------	--------	-------	--------	-------	--------	-------	--------	-------	--------	-------	--------	-------	--------	-------	--------	-------	--------	-------	--------	-------	--------	-------	--------	-------	--------	-------	--------	-------	--------	-------	--------	-------	--------	-------	--------	-------	--------	-------	--------	-------	--------	-------	--------	-------	--------	-------	--------	-------	--------	-------	--------	-------	--------	-------	--------	-------	--------	-------	--------	-------	--------	-------	--------	-------	--------	-------	--------	-------	--------	-------	--------	-------	--------	-------	--------	-------	--------	-------	--------	-------	--------	-------	--------	-------	--------	-------	--------	-------	--------	-------	--------	-------	--------	-------	--------	-------	--------	-------	--------	-------	--------	-------	--------	-------	--------	-------	--------	-------	--------	-------	--------	-------	--------	-------	--------	-------	--------	-------	--------	-------	--------	-------	--------	-------	--------	-------	--------	-------	--------	-------	--------	-------	--------	-------	--------	-------	--------	-------	--------	-------	--------	-------	--------	-------	--------	-------	--------	-------	--------	-------	--------	-------	--------	-------	--------	-------	--------	-------	--------	-------	--------	-------	--------	-------	--------	-------	--------	-------	--------	-------	--------	-------	--------	-------	--------	-------	--------	-------	--------	-------	--------	-------	--------	-------	--------	-------	--------	-------	--------	-------	--------	-------	--------	-------	--------	-------	--------	-------	--------	-------	--------	-------	--------	-------	--------	-------	--------	-------	--------	-------	--------	-------	--------	-------	--------	-------	--------	-------	--------	-------	--------	-------	--------	-------	--------	-------	--------	-------	--------	-------	--------	-------	--------	-------	--------	-------	--------	-------	--------	-------	--------	-------	--------	-------	--------	-------	--------	-------	--------	-------	--------	-------	--------	-------	--------	-------	--------	-------	--------	-------	--------	-------	--------	-------	--------	-------	--------	-------	--------	-------	--------	-------	--------	-------	--------	-------	--------	-------	--------	-------	--------	-------	--------	-------	--------	-------	--------	-------	--------	-------	--------	-------	--------	-------	--------	-------	--------	-------	--------	-------	--------	-------	--------	-------	--------	-------	--------	-------	--------	-------	--------	-------	--------	-------	--------	-------	--------	-------	--------	-------	--------	-------	--------	-------	--------	-------	--------	-------	--------	-------	--------	-------	--------	-------	--------	-------	--------	-------	--------	-------	--------	-------	--------	-------	--------	-------	--------	-------	--------	-------	--------	-------	--------	-------	--------	-------	--------	-------	--------	-------	--------	-------	--------	-------	--------	-------	--------	-------	--------	-------	--------	-------	--------	-------	--------	-------	--------	-------	--------	-------	--------	-------	--------	-------	--------	-------	--------	-------	--------	-------	--------	-------	--------	-------	--------	-------	--------	-------	--------	-------	--------	-------	--------	-------	--------	-------	--------	-------	--------	-------	--------	-------	--------	-------	--------	-------	--------	-------	--------	-------	--------	-------	--------	-------	--------	-------	--------	-------	--------	-------	--------	-------	--------	-------	--------	-------	--------	-------	--------	-------	--------	-------	--------	-------	--------	-------	--------	-------	--------	-------	--------	-------	--------	-------	--------	-------	--------	-------	--------	-------	--------	-------	--------	-------	--------	-------	--------	-------	--------	-------	--------	-------	--------	-------	--------	-------	--------	-------	--------	-------	--------	-------	--------	-------	--------	-------	--------	-------	--------	-------	--------	-------	--------	-------	--------	-------	--------	-------	--------	-------	--------	-------	--------	-------	--------	-------	--------	-------	--------	-------	--------	-------	--------	-------	--------	-------	--------	-------	--------	-------	--------	-------	--------	-------	--------	-------	--------	-------	--------	-------	--------	-------	--------	-------	--------	-------	--------	-------	--------	-------	--------	-------	--------	-------	--------	-------	--------	-------	--------	-------	--------	-------	--------	-------	--------	-------	--------	-------	--------	-------	--------	-------	--------	-------	--------	-------	--------	-------	--------	-------	--------	-------	--------	-------	--------	-------	--------	-------	--------	-------	--------	-------	--------	-------	--------	-------	--------	-------	--------	-------	--------	-------	--------	-------	--------	-------	--------	-------	--------	-------	--------	-------	--------	-------	--------	-------	--------	-------	--------	-------	--------	-------	--------	-------	--------	-------	--------	-------	--------	-------	--------	-------	--------	-------	--------	-------	--------	-------	--------	-------	--------	-------	----

Gr. Nr. K-8

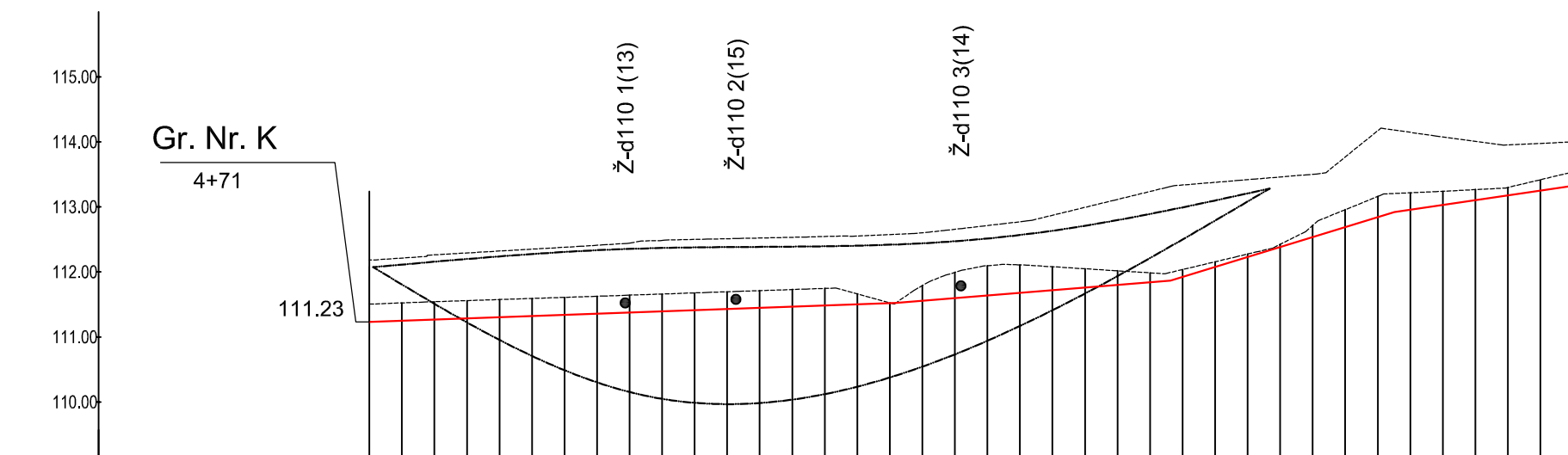
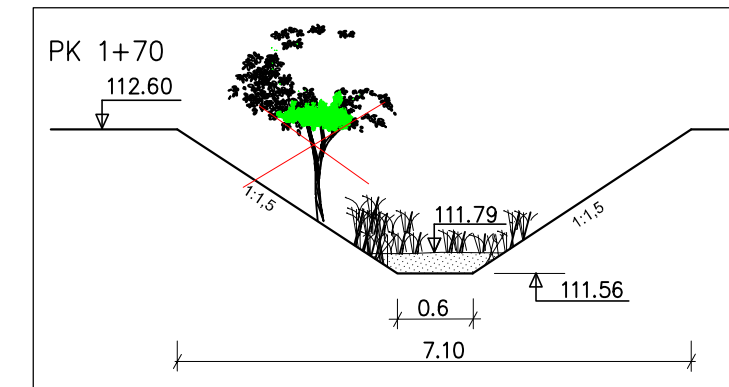

DUGNO NUOLYDIS (prom.) PROJEKTUOJAMAS (ESAMAS)	ATSTUMAS (m)
ŠLAITU KOEF., IR DUGNO PLOTIS PROJEKTUOJAMAS (ESAMAS)	ATSTUMAS (m)
PIKETAI	
ŽEMĖS PAVIRŠIAUS ALTIUDĖS (m)	
ESAMOS GROVIO DUGNO ALTIUDĖS (m)	
PROJEKTUOJAMOS GROVIO DUGNO ALTIUDĖS (m)	
KASAMŲ ŠAŅAŠŲ ARBA GRUNTO STORIS (m)	
GRUNTAS	
ŠLAITU IR DUGNO STIPRINIMAS PROJEKTUOJAMAS (ESAMAS)	
ESAMOS DEFORMACIJOS	
PROJEKTUOJAMI DARBAI	

1.8	4.0	15.3	7.3																																																																																																																																																																																																																																																																																																																																																																																																																																																																																																																																																																																																																																																																																																																																																																																																																																																																																																																																																																																																																																												
162	85	69	61																																																																																																																																																																																																																																																																																																																																																																																																																																																																																																																																																																																																																																																																																																																																																																																																																																																																																																																																																																																																																																												
m=1.5; b=0.60 (esamas 0.6-0.9)																																																																																																																																																																																																																																																																																																																																																																																																																																																																																																																																																																																																																																																																																																																																																																																																																																																																																																																																																																																																																																															
0+10	0+20	0+30	0+40	0+50	0+60	0+70	0+80	0+90	1+00	1+10	1+20	1+30	1+40	1+50	1+60	1+70	1+80	1+90	2+00	2+10	2+20	2+30	2+40	2+50	2+60	2+70	2+80	2+90	3+00	3+10	3+20	3+30	3+40	3+50	3+60	3+70																																																																																																																																																																																																																																																																																																																																																																																																																																																																																																																																																																																																																																																																																																																																																																																																																																																																																																																																																																																																											
115.2	111.21	111.54	112.26	112.06	111.56	112.32	112.35	111.59	111.61	111.63	112.41	112.44	111.64	111.66	112.49	111.68	112.50	111.69	111.71	111.73	112.53	112.54	111.75	112.55	111.76	112.56	111.77	112.57	111.78	112.58	111.79	112.59	111.80	112.60	111.81	112.61	111.82	112.62	111.83	112.63	111.84	112.64	111.85	112.65	111.86	112.66	111.87	112.67	111.88	112.68	111.89	112.69	111.90	112.70	111.91	112.71	111.92	112.72	111.93	112.73	111.94	112.74	111.95	112.75	111.96	112.76	111.97	112.77	111.98	112.78	111.99	112.79	112.00	112.80	112.01	112.81	112.02	112.82	112.03	112.83	112.04	112.84	112.05	112.85	112.06	112.86	112.07	112.87	112.08	112.88	112.09	112.89	112.10	112.90	112.11	112.91	112.12	112.92	112.13	112.93	112.14	112.94	112.15	112.95	112.16	112.96	112.17	112.97	112.18	112.98	112.19	112.99	112.20	113.00	112.21	113.01	112.22	113.02	112.23	113.03	112.24	113.04	112.25	113.05	112.26	113.06	112.27	113.07	112.28	113.08	112.29	113.09	112.30	113.10	112.31	113.11	112.32	113.12	112.33	113.13	112.34	113.14	112.35	113.15	112.36	113.16	112.37	113.17	112.38	113.18	112.39	113.19	112.40	113.20	112.41	113.21	112.42	113.22	112.43	113.23	112.44	113.24	112.45	113.25	112.46	113.26	112.47	113.27	112.48	113.28	112.49	113.29	112.50	113.30	112.51	113.31	112.52	113.32	112.53	113.33	112.54	113.34	112.55	113.35	112.56	113.36	112.57	113.37	112.58	113.38	112.59	113.39	112.60	113.40	112.61	113.41	112.62	113.42	112.63	113.43	112.64	113.44	112.65	113.45	112.66	113.46	112.67	113.47	112.68	113.48	112.69	113.49	112.70	113.50	112.71	113.51	112.72	113.52	112.73	113.53	112.74	113.54	112.75	113.55	112.76	113.56	112.77	113.57	112.78	113.58	112.79	113.59	112.80	113.60	112.81	113.61	112.82	113.62	112.83	113.63	112.84	113.64	112.85	113.65	112.86	113.66	112.87	113.67	112.88	113.68	112.89	113.69	112.90	113.70	112.91	113.71	112.92	113.72	112.93	113.73	112.94	113.74	112.95	113.75	112.96	113.76	112.97	113.77	112.98	113.78	112.99	113.79	113.00	113.80	113.01	113.81	113.02	113.82	113.03	113.83	113.04	113.84	113.05	113.85	113.06	113.86	113.07	113.87	113.08	113.88	113.09	113.89	113.10	113.90	113.11	113.91	113.12	113.92	113.13	113.93	113.14	113.94	113.15	113.95	113.16	113.96	113.17	113.97	113.18	113.98	113.19	113.99	113.20	114.00	113.21	114.01	113.22	114.02	113.23	114.03	113.24	114.04	113.25	114.05	113.26	114.06	113.27	114.07	113.28	114.08	113.29	114.09	113.30	114.10	113.31	114.11	113.32	114.12	113.33	114.13	113.34	114.14	113.35	114.15	113.36	114.16	113.37	114.17	113.38	114.18	113.39	114.19	113.40	114.20	113.41	114.21	113.42	114.22	113.43	114.23	113.44	114.24	113.45	114.25	113.46	114.26	113.47	114.27	113.48	114.28	113.49	114.29	113.50	114.30	113.51	114.31	113.52	114.32	113.53	114.33	113.54	114.34	113.55	114.35	113.56	114.36	113.57	114.37	113.58	114.38	113.59	114.39	113.60	114.40	113.61	114.41	113.62	114.42	113.63	114.43	113.64	114.44	113.65	114.45	113.66	114.46	113.67	114.47	113.68	114.48	113.69	114.49	113.70	114.50	113.71	114.51	113.72	114.52	113.73	114.53	113.74	114.54	113.75	114.55	113.76	114.56	113.77	114.57	113.78	114.58	113.79	114.59	113.80	114.60	113.81	114.61	113.82	114.62	113.83	114.63	113.84	114.64	113.85	114.65	113.86	114.66	113.87	114.67	113.88	114.68	113.89	114.69	113.90	114.70	113.91	114.71	113.92	114.72	113.93	114.73	113.94	114.74	113.95	114.75	113.96	114.76	113.97	114.77	113.98	114.78	113.99	114.79	114.00	114.80	114.01	114.81	114.02	114.82	114.03	114.83	114.04	114.84	114.05	114.85	114.06	114.86	114.07	114.87	114.08	114.88	114.09	114.89	114.10	114.90	114.11	114.91	114.12	114.92	114.13	114.93	114.14	114.94	114.15	114.95	114.16	114.96	114.17	114.97	114.18	114.98	114.19	114.99	114.20	115.00	114.21	115.01	114.22	115.02	114.23	115.03	114.24	115.04	114.25	115.05	114.26	115.06	114.27	115.07	114.28	115.08	114.29	115.09	114.30	115.10	114.31	115.11	114.32	115.12	114.33	115.13	114.34	115.14	114.35	115.15	114.36	115.16	114.37	115.17	114.38	115.18	114.39	115.19	114.40	115.20	114.41	115.21	114.42	115.22	114.43	115.23	114.44	115.24	114.45	115.25	114.46	115.26	114.47	115.27	114.48	115.28	114.49	115.29	114.50	115.30	114.51	115.31	114.52	115.32	114.53	115.33	114.54	115.34	114.55	115.35	114.56	115.36	114.57	115.37	114.58	115.38	114.59	115.39	114.60	115.40	114.61	115.41	114.62	115.42	114.63	115.43	114.64	115.44	114.65	115.45	114.66	115.46	114.67	115.47	114.68	115.48	114.69	115.49	114.70	115.50	114.71	115.51	114.72	115.52	114.73	115.53	114.74	115.54	114.75	115.55	114.76	115.56	114.77	115.57	114.78	115.58	114.79	115.59	114.80	115.60	114.81	115.61	114.82	115.62	114.83	115.63	114.84	115.64	114.85	115.65	114.86	115.66	114.87	115.67	114.88	115.68	114.89	115.69	114.90	115.70	114.91	115.71	114.92	115.72	114.93	115.73	114.94	115.74	114.95	115.75	114.96	115.76	114.97	115.77	114.98	115.78	114.99	115.79	115.00	115.80	115.01	115.81	115.02	115.82	115.03	115.83	115.04	115.84	115.05	115.85	115.06	115.86	115.07	115.87	115.08	115.88	115.09	115.89	115.10	115.90	115.11	115.91	115.12	115.92	115.13	115.93	115.14	115.94	115.15	115.95	115.16	115.96	115.17	115.97	115.18	115.98	115.19	115.99	115.20	116.00	115.21	116.01	115.22	116.02	115.23	116.03	115.24	116.04	115.25	116.05	115.26	116.06	115.27	116.07	115.28	116.08	115.29	116.09	115.30	116.10	115.31	116.11	115.32	116.12	115.33	116.13	115.34	116.14	115.35	116.15	115.36	116.16	115.37	116.17	115.38	116.18	115.39	116.19	115.40	116.20	115.41	116.21	115.42	116.22	115.43	116.23	115.44	116.24	115.45	116.25	115.46	116.26	115.47	116.27	115.48	116.28	115.49	116.29	115.50	116.30	115.51	116.31	115.52	116.32	115.53	116.33	115.54	116.34	115.55	116.35	115.56	116.36	115.57	116.37	115.58	116.38	115.59	116.39	115.60	116.40	115.61	116.41	115.62	116.42	115.63	116.43	115.64	116.44	115.65	116.45	115.66	116.46	115.67	116.47	115.68	116.48	115.69	116.49	115.70	116.50	115.71	116.51	115.72	116.52	115.73	116.53	115.74	116.54	115.75	116.55	115.76	116.56	115.77	116.57	115.78	116.58	115.79	116.59	115.80	116.60	115.81	116.61	115.82	116.62	115.83	116.63	115.84	116.64	115.85	116.65	115.86	116.66	115.87	116.67	115.88	116.68	115.89	116.69	115.90	116.70	115.91	116.71	115.92	116.72	115.93	116.73	115.94	116.74	115.95	116.75	115.96	116.76	115.97	116.77	115.98	116.78	115.99	116.79	116.00	116.80	116.01	116.81	116.02	116.82	116.03	116.83	116.04	116.84	116.05	116.85	116.06	116.86	116.07	116.87	116.08	116.88	116.09	116.89	116.10	116.90	116.11	116.91	116.12	116.92	116.13	116.93	116.14	116.94	116.15	116.95	116.16	116.96	116.17	116.97	116.18	116.98	116.19	116.99	117.00	117.01	117.02	117.03	117.04	117.05	117.06	117.07	117.08	117.09	117.10	117.11	117.12	117.13	117.14	117.15	117.16	117.17	117.18	117.19	117.20	117.21	117.22	117.23	117.24	117.25	117.26	117.27	117.28	117.29	117.30	117.31	117.32	117.33	117.34	117.35	117.36	117.37	117.38	117.39	117.40	117.41	117.42	117.43	117.44	117.45	117.46	117.47	117.48	117.49	117.50	117.51	117.52	117.53	117.54	117.55	117.56	117.57	117.58	117.59	117.60	117.61	117.62	117.63	117.64	117.65	117.66	117.67	117.68	117.69	117.70	117.71	117.72	117.73	117.74	117.75	117.76	117.77	117.78	117.79	117.80	117.81	117.82	117.83	117.84	117.85	117.86	117.87	117.88	117.89	117.90	117.91	117.92	117.93	117.94

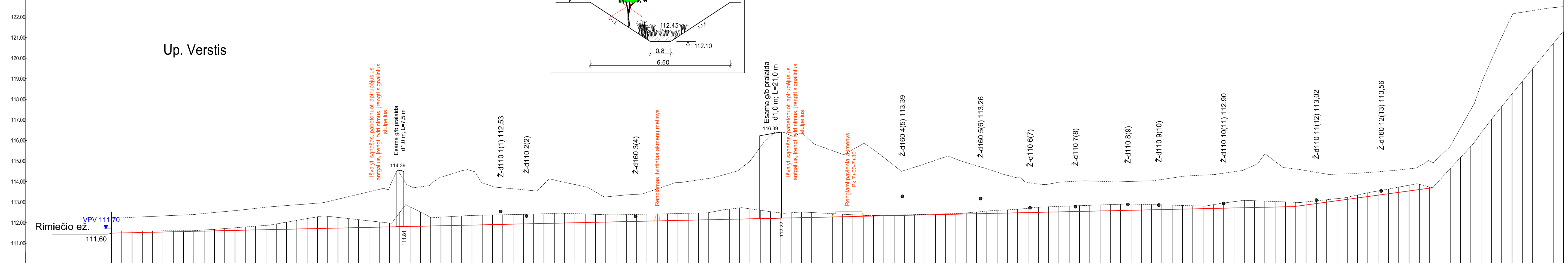

DUGNO NUOLYDIS (prom.) PROJEKTUOJAMAS (ESAMAS)
ATSTUMAS (m)
ŠLAITŲ KOEF., IR DUGNO PLOTIS PROJEKTUOJAMAS (ESAMAS)
ATSTUMAS (m)

PIKETAI
ŽEMĖS PAVIRŠIAUS ALTIUDĖS (m)
ESAMOS GROIOVO DUGNO ALTIUDĖS (m)
PROJEKTUOJAMOS GROIOVO DUGNO ALTIUDĖS (m)
KASAMŲ ŠAŅAŠŲ ARBA GRUNTO STORIS (m)
GRUNTAS
ŠLAITŲ IR DUGNO STIPRINIMAS PROJEKTUOJAMAS (ESAMAS)
ESAMOS DEFORMACIJOS
PROJEKTUOJAMI DARBAI

0+10	112.24	111.60	111.50	-0.10	Sluoksniuotas priemolis
0+20	112.26	111.60	111.51	-0.09	Šlaitų stabilūs, apaugo žolinė augmenija, dugne šašanos (Nestiprinama)
0+30	112.28	111.60	111.53	-0.08	
0+40	112.31	111.61	111.54	-0.07	
0+50	112.33	111.61	111.55	-0.06	
0+60	112.35	111.61	111.56	-0.05	
0+70	112.38	111.61	111.57	-0.04	
0+80	112.40	111.61	111.58	-0.03	
0+90	112.45	111.64	111.59	-0.05	
1+00	112.50	111.60	111.60	-0.07	
1+10	112.54	111.72	111.63	-0.13	
1+20	112.59	111.75	111.63	-0.13	
1+30	112.64	111.79	111.64	-0.15	
1+40	112.70	111.83	111.65	-0.18	
1+50	112.75	111.87	111.66	-0.21	
1+60	112.79	111.94	111.67	-0.27	
1+70	112.83	111.99	111.68	-0.34	
1+80	112.87	112.11	111.69	-0.42	
1+90	112.91	112.20	111.71	-0.49	
2+00	112.95	112.28	111.72	-0.57	
2+10	113.02	112.31	111.73	-0.58	
2+20	113.14	112.26	111.74	-0.52	
2+30	113.26	112.20	111.75	-0.45	
2+40	113.38	112.15	111.76	-0.38	
2+50	113.50	112.09	111.77	-0.32	
2+60	113.62	112.04	111.78	-0.25	
2+70	113.73	111.98	111.80	-0.19	
2+80	113.78	111.93	111.81	-0.89	
2+90	113.76	112.76	111.82	-0.95	
3+00	113.83	112.36	111.83	-0.47	
3+10	113.86	112.25	111.84	-0.41	
3+20	114.21	112.27	111.85	-0.42	
3+30	114.37	112.30	111.86	-0.44	
3+40	114.53	112.33	111.87	-0.46	
3+50	114.52	112.35	111.88	-0.47	
3+60	114.59	112.36	111.90	-0.47	
3+70	114.59	112.39	111.91	-0.47	
3+80	113.69	112.39	111.92	-0.47	
3+90	113.65	112.40	111.93	-0.47	
4+00	113.60	112.41	111.94	-0.47	
4+10	113.60	112.42	111.95	-0.47	
4+20	113.88	112.43	111.96	-0.47	
4+30	114.08	112.45	111.97	-0.48	
4+40	113.96	112.46	111.99	-0.47	
4+50	113.86	112.44	112.00	-0.44	
4+60	113.86	112.44	112.00	-0.44	
4+70	113.75	112.42	112.01	-0.41	
4+80	113.75	112.42	112.01	-0.41	
4+90	113.75	112.42	112.01	-0.41	
5+00	113.83	112.43	112.02	-0.39	
5+10	113.86	112.43	112.02	-0.36	
5+20	113.86	112.39	112.03	-0.34	
5+30	113.96	112.39	112.04	-0.34	
5+40	113.96	112.39	112.04	-0.34	
5+50	113.96	112.40	112.05	-0.34	
5+60	113.96	112.40	112.05	-0.34	
5+70	113.96	112.41	112.06	-0.34	
5+80	113.96	112.41	112.06	-0.34	
5+90	113.96	112.41	112.06	-0.34	
6+00	114.40	112.41	112.06	-0.34	
6+10	114.59	112.42	112.07	-0.54	
6+20	114.99	112.67	112.19	-0.49	
6+30	115.67	112.60	112.20	-0.40	
6+40	116.21	112.53	112.21	-0.32	
6+50	116.33	112.49	112.22	-0.25	
6+60	116.23	112.48	112.23	-0.25	
6+70	116.36	112.52	112.24	-0.28	
6+80	116.36	112.49	112.25	-0.24	
6+90	115.69	112.47	112.27	-0.20	
7+00	115.90	112.44	112.28	-0.16	
7+10	115.33	112.41	112.29	-0.12	
7+20	115.56	112.39	112.30	-0.09	
7+30	115.84	112.36	112.31	-0.05	
7+40	115.55	112.34	112.32	-0.02	
7+50	115.17	112.36	112.33	-0.02	
7+60	114.78	112.37	112.34	-0.02	
7+70	114.54	112.38	112.35	-0.02	
7+80	114.70	112.39	112.37	-0.03	
7+90	114.86	112.41	112.38	-0.03	
8+00	115.03	112.42	112.40	-0.03	
8+10	115.21	112.43	112.41	-0.03	
8+20	115.09	112.44	112.42	-0.03	
8+30	114.92	112.47	112.42	-0.05	
8+40	114.77	112.52	112.43	-0.09	
8+50	114.62	112.57	112.45	-0.12	
8+60	114.46	112.60	112.46	-0.14	
8+70	114.30	112.62	112.47	-0.16	
8+80	114.19	112.65	112.48	-0.18	
8+90	113.96	112.70	112.49	-0.21	
9+00	113.89	112.88	112.51	-0.26	
9+10	113.87	112.79	112.52	-0.27	
9+20	113.87	112.81	112.54	-0.27	
9+30	114.00	112.81	112.55	-0.28	
9+40	114.02	112.83	112.56	-0.28	
9+50	114.03	112.84	112.56	-0.29	
9+60	114.01	112.86	112.57	-0.29	
9+70	113.99	112.88	112.58	-0.30	
9+80	113.99	112.90	112.59	-0.31	
9+90	114.00	112.91	112.60	-0.30	
10+00	114.02	112.89	112.61	-0.28	
10+10	114.04	112.88	112.62	-0.25	
10+20	114.10	112.86	112.64	-0.23	
10+30	114.18	112.85	112.65	-0.20	
10+40	114.25	112.84	112.66	-0.18	
10+50	114.29	112.82	112.67	-0.15	
10+60	114.31	112.81	112.68	-0.13	
10+70	114.34	112.88	112.69	-0.18	
10+80	114.41	112.96	112.70	-0.25	
10+90	114.48	113.01	112.71	-0.31	
11+00	114.57	113.08	112.73	-0.36	
11+10	114.79	113.07	112.74	-0.33	
11+20	115.05	113.05	112.75	-0.30	
11+30	114.98	113.03	112.76	-0.27	
11+40	114.87	113.01	112.77	-0.24	
11+50	114.61	112.99	112.78	-0.20	
11+60	114.53	113.01	112.86	-0.15	
11+70	114.45	113.06	112.93	-0.13	
11+80	114.36	113.12	113.00	-0.12	
11+90	114.36	113.17	113.07	-0.10	
12+00	114.38	113.24	113.13	-0.10	
12+10	114.40	113.29	113.20	-0.14	
12+20	114.44	113.45	113.24	-0.18	
12+30	114.44	113.55	113.28	-0.21	
12+40	114.52	113.64	113.34	-0.23	
12+50	114.57	113.73	113.41	-0.25	
12+60	114.62	113.82	113.48	-0.28	
12+70	114.74	113.87	113.54	-0.25	
12+80	114.99	113.93	113.73	-0.25	
12+90	115.23	114.09	114.09	-0.05	
13+00	115.71	115.71	115.71	-0.41	
13+10	115.71	116.61	115.71	-0.90	
13+20	117.50	117.50	117.50	-0.00	
13+30	118.74	118.74	118.74	-0.00	
13+40	119.91	119.91	119.91	-0.00	
13+50	119.91	119.91	119.91	-0.00	
13+60	121.03	121.03	121.03	-0.00	
13+70	122.23	122.23	122.23	-0.00	
13+80	122.31	122.31	122.31	-0.00	
13+90	122.39	122.39	122.39	-0.00	
14+00	122.46	122.46	122.46	-0.00	

Sluoksniuotas priemolis

Šlaitai stabilūs, apaugo žolinė augmenija, dugne šašanos (Nestiprinama)

Dugne šašanos ir aukštastiežė žolinė augmenija

Pavalyti groivio dugną nuo šašanos, pašalinti krūmus

DUGNO NUOLYDIS (prom.) PROJEKTUOJAMAS (ESAMAS)
ATSTUMAS (m)
ŠLAITŲ KOEF., IR DUGNO PLOTIS PROJEKTUOJAMAS (ESAMAS)
ATSTUMAS (m)

PIKETAI
ŽEMĖS PAVIRŠIAUS ALTIUDĖS (m)
ESAMOS GROIOVO DUGNO ALTIUDĖS (m)
PROJEKTUOJAMOS GROIOVO DUGNO ALTIUDĖS (m)
KASAMŲ ŠAŅAŠŲ ARBA GRUNTO STORIS (m)
GRUNTAS
ŠLAITŲ IR DUGNO STIPRINIMAS PROJEKTUOJAMAS (ESAMAS)
ESAMOS DEFORMACIJOS
PROJEKTUOJAMI DARBAI

0+10	117.93	117.93	116.33	-0.01
0+20	118.18	118.18	116.44	-0.03
0+30	118.36	118.36	116.55	-0.06
0+40	118.46	118.46	116.68	-0.10
0+50	118.52	118.52	116.80	-0.14
0+60	118.59	118.59	116.93	-0.19
0+70	118.69	118.69	117.07	-0.24
0+80	118.83	118.83	117.21	-0.29
0+90	118.93	118.93	117.35	-0.34
1+00	119.07	119.07	117.47	-0.38
1+10	119.16	119.16	117.55	-0.38
1+20	119.46	119.46	117.67	-0.42
1+30	120.26	120.26	117.74	-0.45
1+40	121.01	121.01	117.83	-0.42
1+50	121.06	121.06	117.83	-0.41
1+60	121.11	121.11	117.84	-0.39
1+70	121.13	121.13	117.84	-0.18
1+80	121.13	121.13	117.84	-0.12
1+90	121.13	121.13	117.84	-0.08
2+00	121.13	121.13	117.84	-0.16
2+10	121.13	121.13	117.84	-0.26
2+20	121.13	121.13	117.84	-0.36
2+30	121.13	121.13	117.84	-0.43
2+40	121.13	121.13	117.84	-0.46
2+50	121.13	121.13	117.84	-0.50
2+60	121.13	121.13	117.84	-0.53
2+70	121.13	121.13	117.84	-0.56
2+80	121.13	121.13	117.84	-0.58
2+90	121.13	121.13	117.84	-0.49
3+00	121.13	121.13	117.84	-0.39
3+10	121.13	121.13	117.84	-0.29
3+20	121.13	121.13	117.84	-0.27

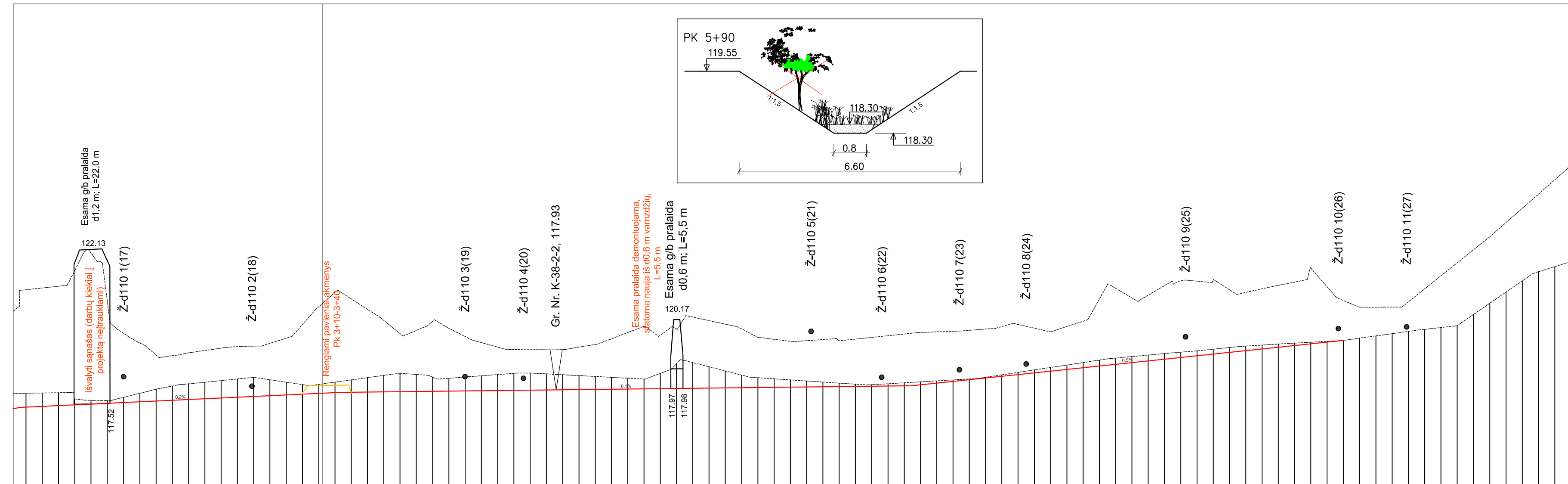

2.3	0.6	5.2
197	351	266
m=1.5; b=0.80 (esamas 0.7-1.0)		

1-40	121.01	117.83	117.40	-0.42	1-40	121.01	117.83	117.40	-0.42
1-60	121.06	117.88	117.45	-0.41	1-60	121.06	117.88	117.45	-0.41
1-80	121.11	117.93	117.50	-0.39	1-80	121.11	117.93	117.50	-0.39
1-100	121.16	117.98	117.55	-0.38	1-100	121.16	117.98	117.55	-0.38
1-120	121.21	118.03	117.60	-0.36	1-120	121.21	118.03	117.60	-0.36
1-140	121.26	118.08	117.65	-0.35	1-140	121.26	118.08	117.65	-0.35
1-160	121.31	118.13	117.70	-0.34	1-160	121.31	118.13	117.70	-0.34
1-180	121.36	118.18	117.75	-0.33	1-180	121.36	118.18	117.75	-0.33
1-200	121.41	118.23	117.80	-0.32	1-200	121.41	118.23	117.80	-0.32
1-220	121.46	118.28	117.85	-0.31	1-220	121.46	118.28	117.85	-0.31
1-240	121.51	118.33	117.90	-0.30	1-240	121.51	118.33	117.90	-0.30
1-260	121.56	118.38	117.95	-0.29	1-260	121.56	118.38	117.95	-0.29
1-280	121.61	118.43	118.00	-0.28	1-280	121.61	118.43	118.00	-0.28
1-300	121.66	118.48	118.05	-0.27	1-300	121.66	118.48	118.05	-0.27
1-320	121.71	118.53	118.10	-0.26	1-320	121.71	118.53	118.10	-0.26
1-340	121.76	118.58	118.15	-0.25	1-340	121.76	118.58	118.15	-0.25
1-360	121.81	118.63	118.20	-0.24	1-360	121.81	118.63	118.20	-0.24
1-380	121.86	118.68	118.25	-0.23	1-380	121.86	118.68	118.25	-0.23
1-400	121.91	118.73	118.30	-0.22	1-400	121.91	118.73	118.30	-0.22
1-420	121.96	118.78	118.35	-0.21	1-420	121.96	118.78	118.35	-0.21
1-440	122.01	118.83	118.40	-0.20	1-440	122.01	118.83	118.40	-0.20
1-460	122.06	118.88	118.45	-0.19	1-460	122.06	118.88	118.45	-0.19
1-480	122.11	118.93	118.50	-0.18	1-480	122.11	118.93	118.50	-0.18
1-500	122.16	118.98	118.55	-0.17	1-500	122.16	118.98	118.55	-0.17
1-520	122.21	119.03	118.60	-0.16	1-520	122.21	119.03	118.60	-0.16
1-540	122.26	119.08	118.65	-0.15	1-540	122.26	119.08	118.65	-0.15
1-560	122.31	119.13	118.70	-0.14	1-560	122.31	119.13	118.70	-0.14
1-580	122.36	119.18	118.75	-0.13	1-580	122.36	119.18	118.75	-0.13
1-600	122.41	119.23	118.80	-0.12	1-600	122.41	119.23	118.80	-0.12
1-620	122.46	119.28	118.85	-0.11	1-620	122.46	119.28	118.85	-0.11
1-640	122.51	119.33	118.90	-0.10	1-640	122.51	119.33	118.90	-0.10
1-660	122.56	119.38	118.95	-0.09	1-660	122.56	119.38	118.95	-0.09
1-680	122.61	119.43	119.00	-0.08	1-680	122.61	119.43	119.00	-0.08
1-700	122.66	119.48	119.05	-0.07	1-700	122.66	119.48	119.05	-0.07
1-720	122.71	119.53	119.10	-0.06	1-720	122.71	119.53	119.10	-0.06
1-740	122.76	119.58	119.15	-0.05	1-740	122.76	119.58	119.15	-0.05
1-760	122.81	119.63	119.20	-0.04	1-760	122.81	119.63	119.20	-0.04
1-780	122.86	119.68	119.25	-0.03	1-780	122.86	119.68	119.25	-0.03
1-800	122.91	119.73	119.30	-0.02	1-800	122.91	119.73	119.30	-0.02
1-820	122.96	119.78	119.35	-0.01	1-820	122.96	119.78	119.35	-0.01
1-840	123.01	119.83	119.40	0.00	1-840	123.01	119.83	119.40	0.00
1-860	123.06	119.88	119.45	0.00	1-860	123.06	119.88	119.45	0.00
1-880	123.11	119.93	119.50	0.00	1-880	123.11	119.93	119.50	0.00
1-900	123.16	119.98	119.55	0.00	1-900	123.16	119.98	119.55	0.00
1-920	123.21	120.03	119.60	0.00	1-920	123.21	120.03	119.60	0.00
1-940	123.26	120.08	119.65	0.00	1-940	123.26	120.08	119.65	0.00
1-960	123.31	120.13	119.70	0.00	1-960	123.31	120.13	119.70	0.00
1-980	123.36	120.18	119.75	0.00	1-980	123.36	120.18	119.75	0.00
1-1000	123.41	120.23	119.80	0.00	1-1000	123.41	120.23	119.80	0.00

Priemolis sluoksniuotas su priemoliu

Šlaitai stabilūs, apaugo žolinė augmenija, dugne sąnašos (Nestiprinama)

Dugne sąnašos ir aukštastiebi žolinė augmenija

Pavalyti griovio dugną nuo sąnašų, pašalinti krūmus

GP - 26 - TDP - 01 - B.2	Lapai	Lėpų	Laido
	8	13	0

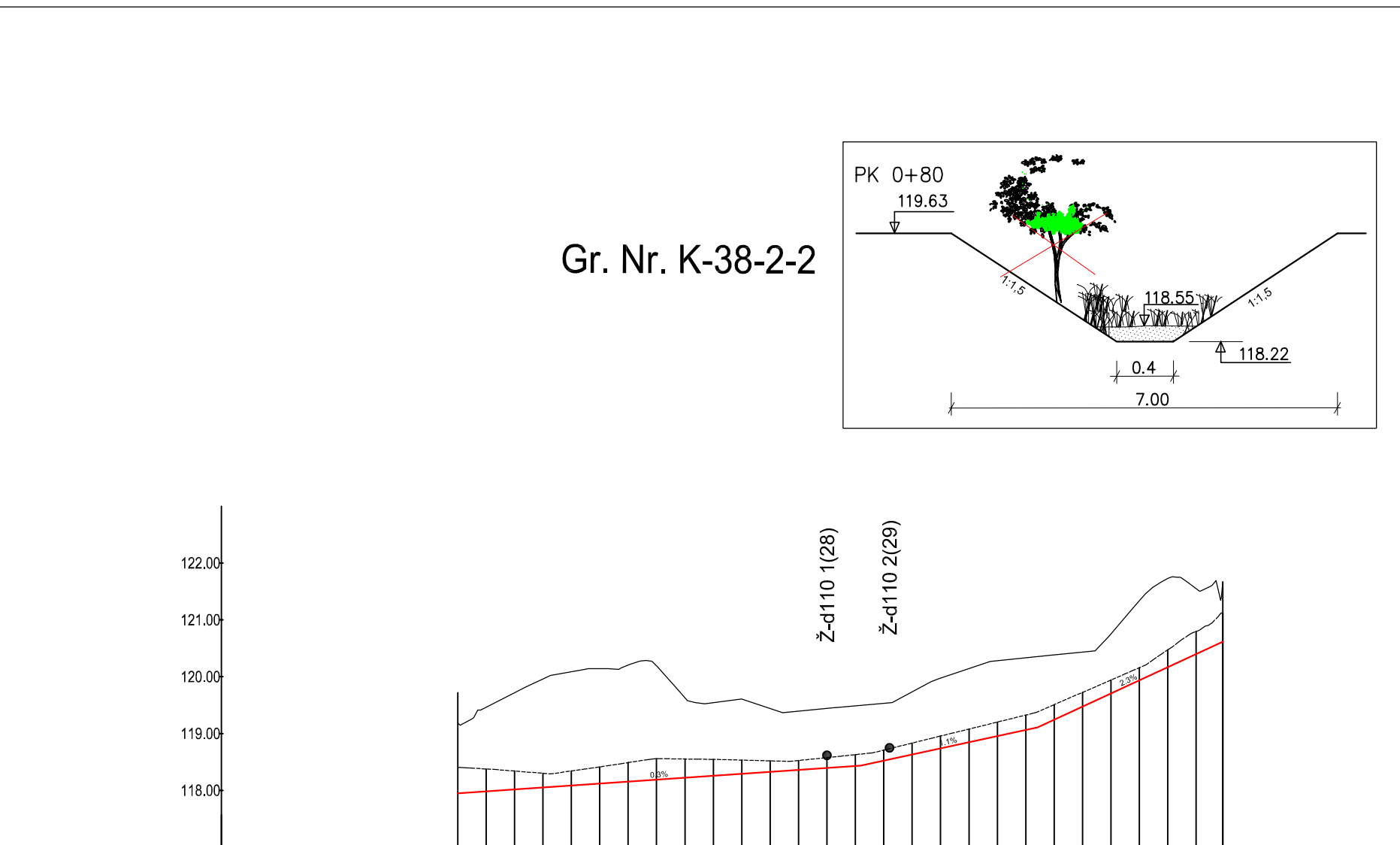

3.5	10.8	23.1
142	62	65
m=1.5; b=0.40 (esamas 0.5-0.6)		

0+10	119.46	118.38	117.98	-0.40	0+10	119.46	118.38	117.98	-0.40
0+20	119.51	118.43	118.03	-0.32	0+20	119.51	118.43	118.03	-0.32
0+30	119.56	118.48	118.08	-0.25	0+30	119.56	118.48	118.08	-0.25
0+40	119.61	118.53	118.13	-0.26	0+40	119.61	118.53	118.13	-0.26
0+50	119.66	118.58	118.18	-0.29	0+50	119.66	118.58	118.18	-0.29
0+60	119.71	118.63	118.23	-0.34	0+60	119.71	118.63	118.23	-0.34
0+70	119.76	118.68	118.28	-0.37	0+70	119.76	118.68	118.28	-0.37
0+80	119.81	118.73	118.33	-0.33	0+80	119.81	118.73	118.33	-0.33
0+90	119.86	118.78	118.38	-0.29	0+90	119.86	118.78	118.38	-0.29
0+100	119.91	118.83	118.43	-0.24	0+100	119.91	118.83	118.43	-0.24
0+110	119.96	118.88	118.48	-0.19	0+110	119.96	118.88	118.48	-0.19
0+120	120.01	118.93	118.53	-0.16	0+120	120.01	118.93	118.53	-0.16
0+130	120.06	118.98	118.58	-0.18	0+130	120.06	118.98	118.58	-0.18
0+140	120.11	119.03	118.63	-0.20	0+140	120.11	119.03	118.63	-0.20
0+150	120.16	119.08	118.68	-0.19	0+150	120.16	119.08	118.68	-0.19
0+160	120.21	119.13	118.73	-0.22	0+160	120.21	119.13	118.73	-0.22
0+170	120.26	119.18	118.78	-0.23	0+170	120.26	119.18	118.78	-0.23
0+180	120.31	119.23	118.83	-0.25	0+180	120.31	119.23	118.83	-0.25
0+190	120.36	119.28	118.88	-0.26	0+190	120.36	119.28	118.88	-0.26
0+200	120.41	119.33	118.93	-0.27	0+200	120.41	119.33	118.93	-0.27
0+210	120.46	119.38	118.98	-0.25	0+210	120.46	119.38	118.98	-0.25
0+220	120.51	119.43	119.03	-0.24	0+220	120.51	119.43	119.03	-0.24
0+230	120.56	119.48	119.08	-0.22	0+230	120.56	119.48	119.08	-0.22
0+240	120.61	119.53	119.13	-0.21	0+240	120.61	119.53	119.13	-0.21
0+250	120.66	119.58	119.18	-0.20	0+250	120.66	119.58	119.18	-0.20
0+260	120.71	119.63	119.23	-0.19	0+260	120.71	119.63	119.23	-0.19

Priemolis

Šlaitai stabilūs, apaugo žolinė augmenija, dugne sąnašos (Nestiprinama)

Dugne sąnašos ir aukštastiebi žolinė augmenija

Pavalyti griovio dugną nuo sąnašų, pašalinti krūmus

GP - 26 - TDP - 01 - B.2	Lapai	Lėpų	Laido
	9	13	0

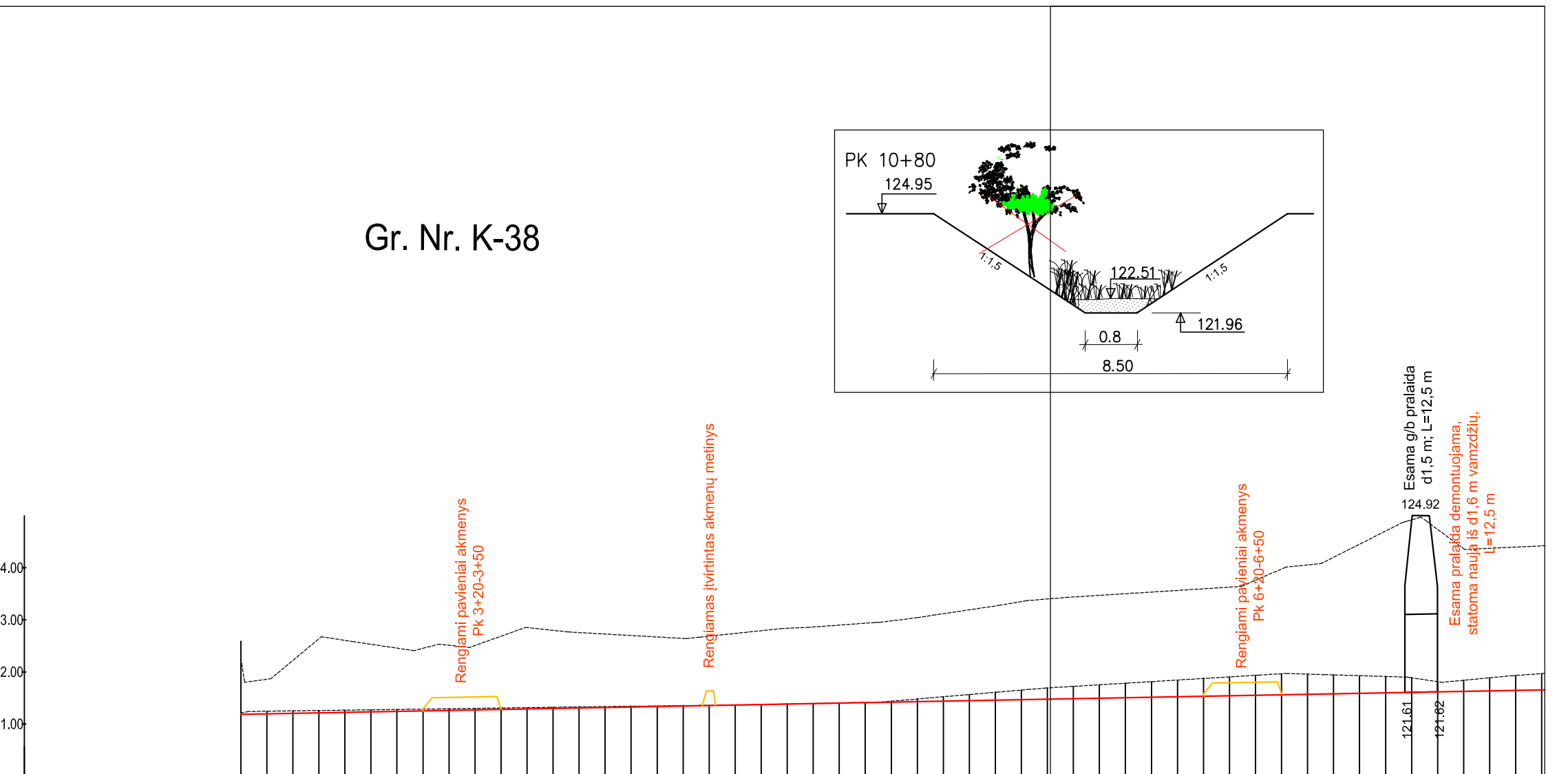

0.9	935
m=1.5; b=0.80 (esamas 0.7-1.1)	

2+60	121.86	121.25	121.19	-0.05	2+60	121.86	121.25	121.19	-0.05
2+80	121.91	121.30	121.24	-0.05	2+80	121.91	121.30	121.24	-0.05
2+90	121.96	121.35	121.29	-0.04	2+90	121.96	121.35	121.29	-0.04
3+00	122.01	121.40	121.34	-0.04	3+00	122.01	121.40	121.34	-0.04
3+10	122.06	121.45	121.39	-0.04	3+10	122.06	121.45	121.39	-0.04
3+20	122.11	121.50	121.44	-0.03	3+20	122.11	121.50	121.44	-0.03
3+30	122.16	121.55	121.49	-0.03	3+30	122.16	121.55	121.49	-0.03
3+40	122.21	121.60	121.54	-0.03	3+40	122.21	121.60	121.54	-0.03
3+50	122.26	121.65	121.59	-0.04	3+50	122.26	121.65	121.59	-0.04
3+60	122.31	121.70	121.64	-0.02	3+60	122.31	121.70	121.64	-0.02
3+70	122.36	121.75	121.69	0.00	3+70	122.36	121.75	121.69	0.00
3+80	122.41	121.80	121.74	0.00	3+80	122.41	121.80	121.74	0.00
3+90	122.46	121.85	121.79	0.00	3+90	122.46	121.85	121.79	0.00
4+00	122.51	121.90	121.84	0.00	4+00	122.51	121.90	121.84	0.00
4+10	122.56	121.95	121.89	0.00	4+10	122.56	121.95	121.89	0.00
4+20	122.61	122.00	121.94	0.00	4+20	122.61	122.00	121.94	0.00
4+30	122.66	122.05	121.99	0.00	4+30	122.66	122.05	121.99	0.00
4+40	122.71	122.10	122.04	0.00	4+40	122.71	122.10	122.04	0.00
4+50	122.76	122.15	122.09	0.00	4+50	122.76	122.15	122.09	0.00
4+60	122.81	122.20	122.14	0.00	4+60	122.81	122.20	122.14	0.00
4+70	122.86	122.25	122.19	0.00	4+70	122.86	1		

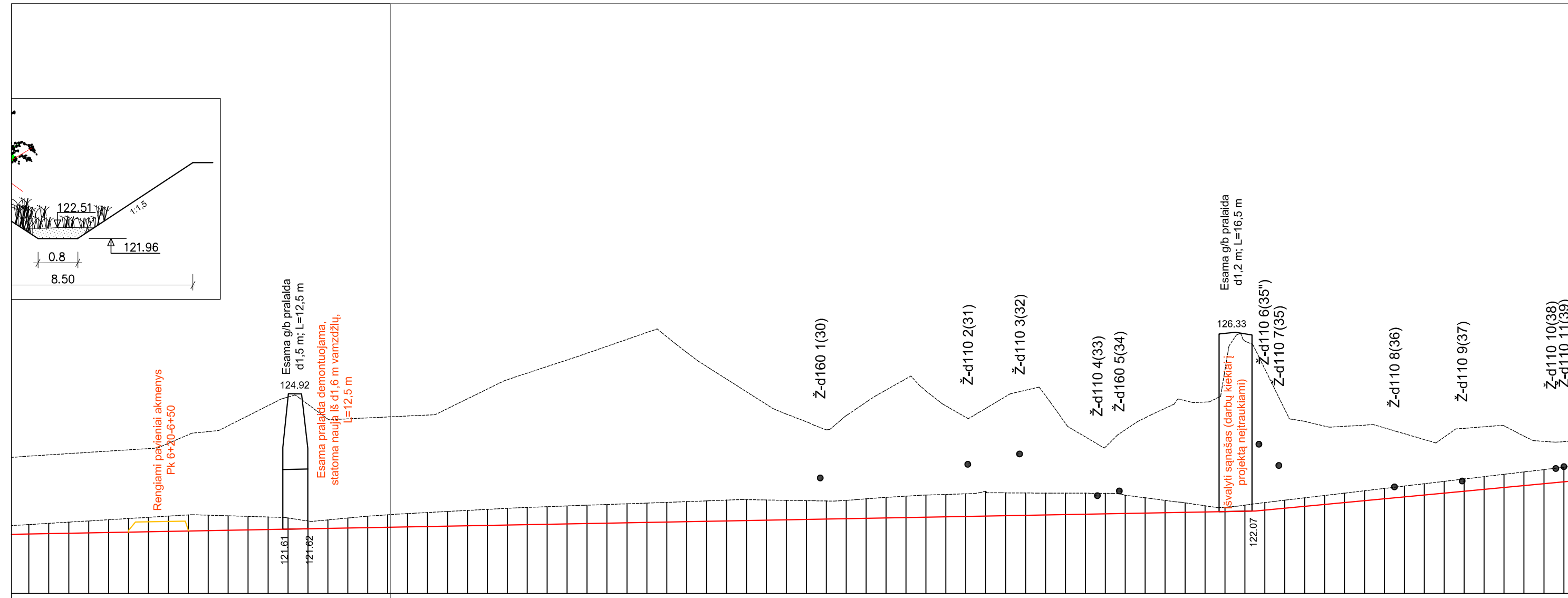

0.9	935	m=1.5; b=0.80 (esamas 0,7-1,1)																																																																																																																																																																																																																																																																																																																																																																																																																																																										
<table border="1"> <tr><td>570</td><td>123.44</td><td>121.72</td></tr> <tr><td>560</td><td>123.47</td><td>121.75</td></tr> <tr><td>550</td><td>123.50</td><td>121.78</td></tr> <tr><td>540</td><td>123.53</td><td>121.81</td></tr> <tr><td>530</td><td>123.56</td><td>121.84</td></tr> <tr><td>520</td><td>123.60</td><td>121.87</td></tr> <tr><td>510</td><td>123.63</td><td>121.90</td></tr> <tr><td>500</td><td>123.66</td><td>121.93</td></tr> <tr><td>490</td><td>123.69</td><td>121.96</td></tr> <tr><td>480</td><td>123.72</td><td>121.99</td></tr> <tr><td>470</td><td>123.75</td><td>122.02</td></tr> <tr><td>460</td><td>123.78</td><td>122.05</td></tr> <tr><td>450</td><td>123.81</td><td>122.08</td></tr> <tr><td>440</td><td>123.84</td><td>122.11</td></tr> <tr><td>430</td><td>123.87</td><td>122.14</td></tr> <tr><td>420</td><td>123.90</td><td>122.17</td></tr> <tr><td>410</td><td>123.93</td><td>122.20</td></tr> <tr><td>400</td><td>123.96</td><td>122.23</td></tr> <tr><td>390</td><td>123.99</td><td>122.26</td></tr> <tr><td>380</td><td>124.02</td><td>122.29</td></tr> <tr><td>370</td><td>124.05</td><td>122.32</td></tr> <tr><td>360</td><td>124.08</td><td>122.35</td></tr> <tr><td>350</td><td>124.11</td><td>122.38</td></tr> <tr><td>340</td><td>124.14</td><td>122.41</td></tr> <tr><td>330</td><td>124.17</td><td>122.44</td></tr> <tr><td>320</td><td>124.20</td><td>122.47</td></tr> <tr><td>310</td><td>124.23</td><td>122.50</td></tr> <tr><td>300</td><td>124.26</td><td>122.53</td></tr> <tr><td>290</td><td>124.29</td><td>122.56</td></tr> <tr><td>280</td><td>124.32</td><td>122.59</td></tr> <tr><td>270</td><td>124.35</td><td>122.62</td></tr> <tr><td>260</td><td>124.38</td><td>122.65</td></tr> <tr><td>250</td><td>124.41</td><td>122.68</td></tr> <tr><td>240</td><td>124.44</td><td>122.71</td></tr> <tr><td>230</td><td>124.47</td><td>122.74</td></tr> <tr><td>220</td><td>124.50</td><td>122.77</td></tr> <tr><td>210</td><td>124.53</td><td>122.80</td></tr> <tr><td>200</td><td>124.56</td><td>122.83</td></tr> <tr><td>190</td><td>124.59</td><td>122.86</td></tr> <tr><td>180</td><td>124.62</td><td>122.89</td></tr> <tr><td>170</td><td>124.65</td><td>122.92</td></tr> <tr><td>160</td><td>124.68</td><td>122.95</td></tr> <tr><td>150</td><td>124.71</td><td>122.98</td></tr> <tr><td>140</td><td>124.74</td><td>123.01</td></tr> <tr><td>130</td><td>124.77</td><td>123.04</td></tr> <tr><td>120</td><td>124.80</td><td>123.07</td></tr> <tr><td>110</td><td>124.83</td><td>123.10</td></tr> <tr><td>100</td><td>124.86</td><td>123.13</td></tr> <tr><td>90</td><td>124.89</td><td>123.16</td></tr> <tr><td>80</td><td>124.92</td><td>123.19</td></tr> <tr><td>70</td><td>124.95</td><td>123.22</td></tr> <tr><td>60</td><td>124.98</td><td>123.25</td></tr> <tr><td>50</td><td>125.01</td><td>123.28</td></tr> <tr><td>40</td><td>125.04</td><td>123.31</td></tr> <tr><td>30</td><td>125.07</td><td>123.34</td></tr> <tr><td>20</td><td>125.10</td><td>123.37</td></tr> <tr><td>10</td><td>125.13</td><td>123.40</td></tr> <tr><td>0</td><td>125.16</td><td>123.43</td></tr> </table>			570	123.44	121.72	560	123.47	121.75	550	123.50	121.78	540	123.53	121.81	530	123.56	121.84	520	123.60	121.87	510	123.63	121.90	500	123.66	121.93	490	123.69	121.96	480	123.72	121.99	470	123.75	122.02	460	123.78	122.05	450	123.81	122.08	440	123.84	122.11	430	123.87	122.14	420	123.90	122.17	410	123.93	122.20	400	123.96	122.23	390	123.99	122.26	380	124.02	122.29	370	124.05	122.32	360	124.08	122.35	350	124.11	122.38	340	124.14	122.41	330	124.17	122.44	320	124.20	122.47	310	124.23	122.50	300	124.26	122.53	290	124.29	122.56	280	124.32	122.59	270	124.35	122.62	260	124.38	122.65	250	124.41	122.68	240	124.44	122.71	230	124.47	122.74	220	124.50	122.77	210	124.53	122.80	200	124.56	122.83	190	124.59	122.86	180	124.62	122.89	170	124.65	122.92	160	124.68	122.95	150	124.71	122.98	140	124.74	123.01	130	124.77	123.04	120	124.80	123.07	110	124.83	123.10	100	124.86	123.13	90	124.89	123.16	80	124.92	123.19	70	124.95	123.22	60	124.98	123.25	50	125.01	123.28	40	125.04	123.31	30	125.07	123.34	20	125.10	123.37	10	125.13	123.40	0	125.16	123.43																																																																																																																																																																																																																																																																												
570	123.44	121.72																																																																																																																																																																																																																																																																																																																																																																																																																																																										
560	123.47	121.75																																																																																																																																																																																																																																																																																																																																																																																																																																																										
550	123.50	121.78																																																																																																																																																																																																																																																																																																																																																																																																																																																										
540	123.53	121.81																																																																																																																																																																																																																																																																																																																																																																																																																																																										
530	123.56	121.84																																																																																																																																																																																																																																																																																																																																																																																																																																																										
520	123.60	121.87																																																																																																																																																																																																																																																																																																																																																																																																																																																										
510	123.63	121.90																																																																																																																																																																																																																																																																																																																																																																																																																																																										
500	123.66	121.93																																																																																																																																																																																																																																																																																																																																																																																																																																																										
490	123.69	121.96																																																																																																																																																																																																																																																																																																																																																																																																																																																										
480	123.72	121.99																																																																																																																																																																																																																																																																																																																																																																																																																																																										
470	123.75	122.02																																																																																																																																																																																																																																																																																																																																																																																																																																																										
460	123.78	122.05																																																																																																																																																																																																																																																																																																																																																																																																																																																										
450	123.81	122.08																																																																																																																																																																																																																																																																																																																																																																																																																																																										
440	123.84	122.11																																																																																																																																																																																																																																																																																																																																																																																																																																																										
430	123.87	122.14																																																																																																																																																																																																																																																																																																																																																																																																																																																										
420	123.90	122.17																																																																																																																																																																																																																																																																																																																																																																																																																																																										
410	123.93	122.20																																																																																																																																																																																																																																																																																																																																																																																																																																																										
400	123.96	122.23																																																																																																																																																																																																																																																																																																																																																																																																																																																										
390	123.99	122.26																																																																																																																																																																																																																																																																																																																																																																																																																																																										
380	124.02	122.29																																																																																																																																																																																																																																																																																																																																																																																																																																																										
370	124.05	122.32																																																																																																																																																																																																																																																																																																																																																																																																																																																										
360	124.08	122.35																																																																																																																																																																																																																																																																																																																																																																																																																																																										
350	124.11	122.38																																																																																																																																																																																																																																																																																																																																																																																																																																																										
340	124.14	122.41																																																																																																																																																																																																																																																																																																																																																																																																																																																										
330	124.17	122.44																																																																																																																																																																																																																																																																																																																																																																																																																																																										
320	124.20	122.47																																																																																																																																																																																																																																																																																																																																																																																																																																																										
310	124.23	122.50																																																																																																																																																																																																																																																																																																																																																																																																																																																										
300	124.26	122.53																																																																																																																																																																																																																																																																																																																																																																																																																																																										
290	124.29	122.56																																																																																																																																																																																																																																																																																																																																																																																																																																																										
280	124.32	122.59																																																																																																																																																																																																																																																																																																																																																																																																																																																										
270	124.35	122.62																																																																																																																																																																																																																																																																																																																																																																																																																																																										
260	124.38	122.65																																																																																																																																																																																																																																																																																																																																																																																																																																																										
250	124.41	122.68																																																																																																																																																																																																																																																																																																																																																																																																																																																										
240	124.44	122.71																																																																																																																																																																																																																																																																																																																																																																																																																																																										
230	124.47	122.74																																																																																																																																																																																																																																																																																																																																																																																																																																																										
220	124.50	122.77																																																																																																																																																																																																																																																																																																																																																																																																																																																										
210	124.53	122.80																																																																																																																																																																																																																																																																																																																																																																																																																																																										
200	124.56	122.83																																																																																																																																																																																																																																																																																																																																																																																																																																																										
190	124.59	122.86																																																																																																																																																																																																																																																																																																																																																																																																																																																										
180	124.62	122.89																																																																																																																																																																																																																																																																																																																																																																																																																																																										
170	124.65	122.92																																																																																																																																																																																																																																																																																																																																																																																																																																																										
160	124.68	122.95																																																																																																																																																																																																																																																																																																																																																																																																																																																										
150	124.71	122.98																																																																																																																																																																																																																																																																																																																																																																																																																																																										
140	124.74	123.01																																																																																																																																																																																																																																																																																																																																																																																																																																																										
130	124.77	123.04																																																																																																																																																																																																																																																																																																																																																																																																																																																										
120	124.80	123.07																																																																																																																																																																																																																																																																																																																																																																																																																																																										
110	124.83	123.10																																																																																																																																																																																																																																																																																																																																																																																																																																																										
100	124.86	123.13																																																																																																																																																																																																																																																																																																																																																																																																																																																										
90	124.89	123.16																																																																																																																																																																																																																																																																																																																																																																																																																																																										
80	124.92	123.19																																																																																																																																																																																																																																																																																																																																																																																																																																																										
70	124.95	123.22																																																																																																																																																																																																																																																																																																																																																																																																																																																										
60	124.98	123.25																																																																																																																																																																																																																																																																																																																																																																																																																																																										
50	125.01	123.28																																																																																																																																																																																																																																																																																																																																																																																																																																																										
40	125.04	123.31																																																																																																																																																																																																																																																																																																																																																																																																																																																										
30	125.07	123.34																																																																																																																																																																																																																																																																																																																																																																																																																																																										
20	125.10	123.37																																																																																																																																																																																																																																																																																																																																																																																																																																																										
10	125.13	123.40																																																																																																																																																																																																																																																																																																																																																																																																																																																										
0	125.16	123.43																																																																																																																																																																																																																																																																																																																																																																																																																																																										
4.7	163	m=1.5; b=0.80 (esamas 0,7-1,0)																																																																																																																																																																																																																																																																																																																																																																																																																																																										
<table border="1"> <tr><td>1140</td><td>123.00</td><td>122.07</td></tr> <tr><td>1130</td><td>123.03</td><td>122.10</td></tr> <tr><td>1120</td><td>123.06</td><td>122.13</td></tr> <tr><td>1110</td><td>123.09</td><td>122.16</td></tr> <tr><td>1100</td><td>123.12</td><td>122.19</td></tr> <tr><td>1090</td><td>123.15</td><td>122.22</td></tr> <tr><td>1080</td><td>123.18</td><td>122.25</td></tr> <tr><td>1070</td><td>123.21</td><td>122.28</td></tr> <tr><td>1060</td><td>123.24</td><td>122.31</td></tr> <tr><td>1050</td><td>123.27</td><td>122.34</td></tr> <tr><td>1040</td><td>123.30</td><td>122.37</td></tr> <tr><td>1030</td><td>123.33</td><td>122.40</td></tr> <tr><td>1020</td><td>123.36</td><td>122.43</td></tr> <tr><td>1010</td><td>123.39</td><td>122.46</td></tr> <tr><td>1000</td><td>123.42</td><td>122.49</td></tr> <tr><td>990</td><td>123.45</td><td>122.52</td></tr> <tr><td>980</td><td>123.48</td><td>122.55</td></tr> <tr><td>970</td><td>123.51</td><td>122.58</td></tr> <tr><td>960</td><td>123.54</td><td>122.61</td></tr> <tr><td>950</td><td>123.57</td><td>122.64</td></tr> <tr><td>940</td><td>123.60</td><td>122.67</td></tr> <tr><td>930</td><td>123.63</td><td>122.70</td></tr> <tr><td>920</td><td>123.66</td><td>122.73</td></tr> <tr><td>910</td><td>123.69</td><td>122.76</td></tr> <tr><td>900</td><td>123.72</td><td>122.79</td></tr> <tr><td>890</td><td>123.75</td><td>122.82</td></tr> <tr><td>880</td><td>123.78</td><td>122.85</td></tr> <tr><td>870</td><td>123.81</td><td>122.88</td></tr> <tr><td>860</td><td>123.84</td><td>122.91</td></tr> <tr><td>850</td><td>123.87</td><td>122.94</td></tr> <tr><td>840</td><td>123.90</td><td>122.97</td></tr> <tr><td>830</td><td>123.93</td><td>123.00</td></tr> <tr><td>820</td><td>123.96</td><td>123.03</td></tr> <tr><td>810</td><td>123.99</td><td>123.06</td></tr> <tr><td>800</td><td>124.02</td><td>123.09</td></tr> <tr><td>790</td><td>124.05</td><td>123.12</td></tr> <tr><td>780</td><td>124.08</td><td>123.15</td></tr> <tr><td>770</td><td>124.11</td><td>123.18</td></tr> <tr><td>760</td><td>124.14</td><td>123.21</td></tr> <tr><td>750</td><td>124.17</td><td>123.24</td></tr> <tr><td>740</td><td>124.20</td><td>123.27</td></tr> <tr><td>730</td><td>124.23</td><td>123.30</td></tr> <tr><td>720</td><td>124.26</td><td>123.33</td></tr> <tr><td>710</td><td>124.29</td><td>123.36</td></tr> <tr><td>700</td><td>124.32</td><td>123.39</td></tr> <tr><td>690</td><td>124.35</td><td>123.42</td></tr> <tr><td>680</td><td>124.38</td><td>123.45</td></tr> <tr><td>670</td><td>124.41</td><td>123.48</td></tr> <tr><td>660</td><td>124.44</td><td>123.51</td></tr> <tr><td>650</td><td>124.47</td><td>123.54</td></tr> <tr><td>640</td><td>124.50</td><td>123.57</td></tr> <tr><td>630</td><td>124.53</td><td>123.60</td></tr> <tr><td>620</td><td>124.56</td><td>123.63</td></tr> <tr><td>610</td><td>124.59</td><td>123.66</td></tr> <tr><td>600</td><td>124.62</td><td>123.69</td></tr> <tr><td>590</td><td>124.65</td><td>123.72</td></tr> <tr><td>580</td><td>124.68</td><td>123.75</td></tr> <tr><td>570</td><td>124.71</td><td>123.78</td></tr> <tr><td>560</td><td>124.74</td><td>123.81</td></tr> <tr><td>550</td><td>124.77</td><td>123.84</td></tr> <tr><td>540</td><td>124.80</td><td>123.87</td></tr> <tr><td>530</td><td>124.83</td><td>123.90</td></tr> <tr><td>520</td><td>124.86</td><td>123.93</td></tr> <tr><td>510</td><td>124.89</td><td>123.96</td></tr> <tr><td>500</td><td>124.92</td><td>123.99</td></tr> <tr><td>490</td><td>124.95</td><td>124.02</td></tr> <tr><td>480</td><td>124.98</td><td>124.05</td></tr> <tr><td>470</td><td>125.01</td><td>124.08</td></tr> <tr><td>460</td><td>125.04</td><td>124.11</td></tr> <tr><td>450</td><td>125.07</td><td>124.14</td></tr> <tr><td>440</td><td>125.10</td><td>124.17</td></tr> <tr><td>430</td><td>125.13</td><td>124.20</td></tr> <tr><td>420</td><td>125.16</td><td>124.23</td></tr> <tr><td>410</td><td>125.19</td><td>124.26</td></tr> <tr><td>400</td><td>125.22</td><td>124.29</td></tr> <tr><td>390</td><td>125.25</td><td>124.32</td></tr> <tr><td>380</td><td>125.28</td><td>124.35</td></tr> <tr><td>370</td><td>125.31</td><td>124.38</td></tr> <tr><td>360</td><td>125.34</td><td>124.41</td></tr> <tr><td>350</td><td>125.37</td><td>124.44</td></tr> <tr><td>340</td><td>125.40</td><td>124.47</td></tr> <tr><td>330</td><td>125.43</td><td>124.50</td></tr> <tr><td>320</td><td>125.46</td><td>124.53</td></tr> <tr><td>310</td><td>125.49</td><td>124.56</td></tr> <tr><td>300</td><td>125.52</td><td>124.59</td></tr> <tr><td>290</td><td>125.55</td><td>124.62</td></tr> <tr><td>280</td><td>125.58</td><td>124.65</td></tr> <tr><td>270</td><td>125.61</td><td>124.68</td></tr> <tr><td>260</td><td>125.64</td><td>124.71</td></tr> <tr><td>250</td><td>125.67</td><td>124.74</td></tr> <tr><td>240</td><td>125.70</td><td>124.77</td></tr> <tr><td>230</td><td>125.73</td><td>124.80</td></tr> <tr><td>220</td><td>125.76</td><td>124.83</td></tr> <tr><td>210</td><td>125.79</td><td>124.86</td></tr> <tr><td>200</td><td>125.82</td><td>124.89</td></tr> <tr><td>190</td><td>125.85</td><td>124.92</td></tr> <tr><td>180</td><td>125.88</td><td>124.95</td></tr> <tr><td>170</td><td>125.91</td><td>124.98</td></tr> <tr><td>160</td><td>125.94</td><td>125.01</td></tr> <tr><td>150</td><td>125.97</td><td>125.04</td></tr> <tr><td>140</td><td>125.99</td><td>125.07</td></tr> <tr><td>130</td><td>126.02</td><td>125.10</td></tr> <tr><td>120</td><td>126.05</td><td>125.13</td></tr> <tr><td>110</td><td>126.08</td><td>125.16</td></tr> <tr><td>100</td><td>126.11</td><td>125.19</td></tr> <tr><td>90</td><td>126.14</td><td>125.22</td></tr> <tr><td>80</td><td>126.17</td><td>125.25</td></tr> <tr><td>70</td><td>126.20</td><td>125.28</td></tr> <tr><td>60</td><td>126.23</td><td>125.31</td></tr> <tr><td>50</td><td>126.26</td><td>125.34</td></tr> <tr><td>40</td><td>126.29</td><td>125.37</td></tr> <tr><td>30</td><td>126.32</td><td>125.40</td></tr> <tr><td>20</td><td>126.35</td><td>125.43</td></tr> <tr><td>10</td><td>126.38</td><td>125.46</td></tr> <tr><td>0</td><td>126.41</td><td>125.49</td></tr> </table>			1140	123.00	122.07	1130	123.03	122.10	1120	123.06	122.13	1110	123.09	122.16	1100	123.12	122.19	1090	123.15	122.22	1080	123.18	122.25	1070	123.21	122.28	1060	123.24	122.31	1050	123.27	122.34	1040	123.30	122.37	1030	123.33	122.40	1020	123.36	122.43	1010	123.39	122.46	1000	123.42	122.49	990	123.45	122.52	980	123.48	122.55	970	123.51	122.58	960	123.54	122.61	950	123.57	122.64	940	123.60	122.67	930	123.63	122.70	920	123.66	122.73	910	123.69	122.76	900	123.72	122.79	890	123.75	122.82	880	123.78	122.85	870	123.81	122.88	860	123.84	122.91	850	123.87	122.94	840	123.90	122.97	830	123.93	123.00	820	123.96	123.03	810	123.99	123.06	800	124.02	123.09	790	124.05	123.12	780	124.08	123.15	770	124.11	123.18	760	124.14	123.21	750	124.17	123.24	740	124.20	123.27	730	124.23	123.30	720	124.26	123.33	710	124.29	123.36	700	124.32	123.39	690	124.35	123.42	680	124.38	123.45	670	124.41	123.48	660	124.44	123.51	650	124.47	123.54	640	124.50	123.57	630	124.53	123.60	620	124.56	123.63	610	124.59	123.66	600	124.62	123.69	590	124.65	123.72	580	124.68	123.75	570	124.71	123.78	560	124.74	123.81	550	124.77	123.84	540	124.80	123.87	530	124.83	123.90	520	124.86	123.93	510	124.89	123.96	500	124.92	123.99	490	124.95	124.02	480	124.98	124.05	470	125.01	124.08	460	125.04	124.11	450	125.07	124.14	440	125.10	124.17	430	125.13	124.20	420	125.16	124.23	410	125.19	124.26	400	125.22	124.29	390	125.25	124.32	380	125.28	124.35	370	125.31	124.38	360	125.34	124.41	350	125.37	124.44	340	125.40	124.47	330	125.43	124.50	320	125.46	124.53	310	125.49	124.56	300	125.52	124.59	290	125.55	124.62	280	125.58	124.65	270	125.61	124.68	260	125.64	124.71	250	125.67	124.74	240	125.70	124.77	230	125.73	124.80	220	125.76	124.83	210	125.79	124.86	200	125.82	124.89	190	125.85	124.92	180	125.88	124.95	170	125.91	124.98	160	125.94	125.01	150	125.97	125.04	140	125.99	125.07	130	126.02	125.10	120	126.05	125.13	110	126.08	125.16	100	126.11	125.19	90	126.14	125.22	80	126.17	125.25	70	126.20	125.28	60	126.23	125.31	50	126.26	125.34	40	126.29	125.37	30	126.32	125.40	20	126.35	125.43	10	126.38	125.46	0	126.41	125.49																																																																																																	
1140	123.00	122.07																																																																																																																																																																																																																																																																																																																																																																																																																																																										
1130	123.03	122.10																																																																																																																																																																																																																																																																																																																																																																																																																																																										
1120	123.06	122.13																																																																																																																																																																																																																																																																																																																																																																																																																																																										
1110	123.09	122.16																																																																																																																																																																																																																																																																																																																																																																																																																																																										
1100	123.12	122.19																																																																																																																																																																																																																																																																																																																																																																																																																																																										
1090	123.15	122.22																																																																																																																																																																																																																																																																																																																																																																																																																																																										
1080	123.18	122.25																																																																																																																																																																																																																																																																																																																																																																																																																																																										
1070	123.21	122.28																																																																																																																																																																																																																																																																																																																																																																																																																																																										
1060	123.24	122.31																																																																																																																																																																																																																																																																																																																																																																																																																																																										
1050	123.27	122.34																																																																																																																																																																																																																																																																																																																																																																																																																																																										
1040	123.30	122.37																																																																																																																																																																																																																																																																																																																																																																																																																																																										
1030	123.33	122.40																																																																																																																																																																																																																																																																																																																																																																																																																																																										
1020	123.36	122.43																																																																																																																																																																																																																																																																																																																																																																																																																																																										
1010	123.39	122.46																																																																																																																																																																																																																																																																																																																																																																																																																																																										
1000	123.42	122.49																																																																																																																																																																																																																																																																																																																																																																																																																																																										
990	123.45	122.52																																																																																																																																																																																																																																																																																																																																																																																																																																																										
980	123.48	122.55																																																																																																																																																																																																																																																																																																																																																																																																																																																										
970	123.51	122.58																																																																																																																																																																																																																																																																																																																																																																																																																																																										
960	123.54	122.61																																																																																																																																																																																																																																																																																																																																																																																																																																																										
950	123.57	122.64																																																																																																																																																																																																																																																																																																																																																																																																																																																										
940	123.60	122.67																																																																																																																																																																																																																																																																																																																																																																																																																																																										
930	123.63	122.70																																																																																																																																																																																																																																																																																																																																																																																																																																																										
920	123.66	122.73																																																																																																																																																																																																																																																																																																																																																																																																																																																										
910	123.69	122.76																																																																																																																																																																																																																																																																																																																																																																																																																																																										
900	123.72	122.79																																																																																																																																																																																																																																																																																																																																																																																																																																																										
890	123.75	122.82																																																																																																																																																																																																																																																																																																																																																																																																																																																										
880	123.78	122.85																																																																																																																																																																																																																																																																																																																																																																																																																																																										
870	123.81	122.88																																																																																																																																																																																																																																																																																																																																																																																																																																																										
860	123.84	122.91																																																																																																																																																																																																																																																																																																																																																																																																																																																										
850	123.87	122.94																																																																																																																																																																																																																																																																																																																																																																																																																																																										
840	123.90	122.97																																																																																																																																																																																																																																																																																																																																																																																																																																																										
830	123.93	123.00																																																																																																																																																																																																																																																																																																																																																																																																																																																										
820	123.96	123.03																																																																																																																																																																																																																																																																																																																																																																																																																																																										
810	123.99	123.06																																																																																																																																																																																																																																																																																																																																																																																																																																																										
800	124.02	123.09																																																																																																																																																																																																																																																																																																																																																																																																																																																										
790	124.05	123.12																																																																																																																																																																																																																																																																																																																																																																																																																																																										
780	124.08	123.15																																																																																																																																																																																																																																																																																																																																																																																																																																																										
770	124.11	123.18																																																																																																																																																																																																																																																																																																																																																																																																																																																										
760	124.14	123.21																																																																																																																																																																																																																																																																																																																																																																																																																																																										
750	124.17	123.24																																																																																																																																																																																																																																																																																																																																																																																																																																																										
740	124.20	123.27																																																																																																																																																																																																																																																																																																																																																																																																																																																										
730	124.23	123.30																																																																																																																																																																																																																																																																																																																																																																																																																																																										
720	124.26	123.33																																																																																																																																																																																																																																																																																																																																																																																																																																																										
710	124.29	123.36																																																																																																																																																																																																																																																																																																																																																																																																																																																										
700	124.32	123.39																																																																																																																																																																																																																																																																																																																																																																																																																																																										
690	124.35	123.42																																																																																																																																																																																																																																																																																																																																																																																																																																																										
680	124.38	123.45																																																																																																																																																																																																																																																																																																																																																																																																																																																										
670	124.41	123.48																																																																																																																																																																																																																																																																																																																																																																																																																																																										
660	124.44	123.51																																																																																																																																																																																																																																																																																																																																																																																																																																																										
650	124.47	123.54																																																																																																																																																																																																																																																																																																																																																																																																																																																										
640	124.50	123.57																																																																																																																																																																																																																																																																																																																																																																																																																																																										
630	124.53	123.60																																																																																																																																																																																																																																																																																																																																																																																																																																																										
620	124.56	123.63																																																																																																																																																																																																																																																																																																																																																																																																																																																										
610	124.59	123.66																																																																																																																																																																																																																																																																																																																																																																																																																																																										
600	124.62	123.69																																																																																																																																																																																																																																																																																																																																																																																																																																																										
590	124.65	123.72																																																																																																																																																																																																																																																																																																																																																																																																																																																										
580	124.68	123.75																																																																																																																																																																																																																																																																																																																																																																																																																																																										
570	124.71	123.78																																																																																																																																																																																																																																																																																																																																																																																																																																																										
560	124.74	123.81																																																																																																																																																																																																																																																																																																																																																																																																																																																										
550	124.77	123.84																																																																																																																																																																																																																																																																																																																																																																																																																																																										
540	124.80	123.87																																																																																																																																																																																																																																																																																																																																																																																																																																																										
530	124.83	123.90																																																																																																																																																																																																																																																																																																																																																																																																																																																										
520	124.86	123.93																																																																																																																																																																																																																																																																																																																																																																																																																																																										
510	124.89	123.96																																																																																																																																																																																																																																																																																																																																																																																																																																																										
500	124.92	123.99																																																																																																																																																																																																																																																																																																																																																																																																																																																										
490	124.95	124.02																																																																																																																																																																																																																																																																																																																																																																																																																																																										
480	124.98	124.05																																																																																																																																																																																																																																																																																																																																																																																																																																																										
470	125.01	124.08																																																																																																																																																																																																																																																																																																																																																																																																																																																										
460	125.04	124.11																																																																																																																																																																																																																																																																																																																																																																																																																																																										
450	125.07	124.14																																																																																																																																																																																																																																																																																																																																																																																																																																																										
440	125.10	124.17																																																																																																																																																																																																																																																																																																																																																																																																																																																										
430	125.13	124.20																																																																																																																																																																																																																																																																																																																																																																																																																																																										
420	125.16	124.23																																																																																																																																																																																																																																																																																																																																																																																																																																																										
410	125.19	124.26																																																																																																																																																																																																																																																																																																																																																																																																																																																										
400	125.22	124.29																																																																																																																																																																																																																																																																																																																																																																																																																																																										
390	125.25	124.32																																																																																																																																																																																																																																																																																																																																																																																																																																																										
380	125.28	124.35																																																																																																																																																																																																																																																																																																																																																																																																																																																										
370	125.31	124.38																																																																																																																																																																																																																																																																																																																																																																																																																																																										
360	125.34	124.41																																																																																																																																																																																																																																																																																																																																																																																																																																																										
350	125.37	124.44																																																																																																																																																																																																																																																																																																																																																																																																																																																										
340	125.40	124.47																																																																																																																																																																																																																																																																																																																																																																																																																																																										
330	125.43	124.50																																																																																																																																																																																																																																																																																																																																																																																																																																																										
320	125.46	124.53																																																																																																																																																																																																																																																																																																																																																																																																																																																										
310	125.49	124.56																																																																																																																																																																																																																																																																																																																																																																																																																																																										
300	125.52	124.59																																																																																																																																																																																																																																																																																																																																																																																																																																																										
290	125.55	124.62																																																																																																																																																																																																																																																																																																																																																																																																																																																										
280	125.58	124.65																																																																																																																																																																																																																																																																																																																																																																																																																																																										
270	125.61	124.68																																																																																																																																																																																																																																																																																																																																																																																																																																																										
260	125.64	124.71																																																																																																																																																																																																																																																																																																																																																																																																																																																										
250	125.67	124.74																																																																																																																																																																																																																																																																																																																																																																																																																																																										
240	125.70	124.77																																																																																																																																																																																																																																																																																																																																																																																																																																																										
230	125.73	124.80																																																																																																																																																																																																																																																																																																																																																																																																																																																										
220	125.76	124.83																																																																																																																																																																																																																																																																																																																																																																																																																																																										
210	125.79	124.86																																																																																																																																																																																																																																																																																																																																																																																																																																																										
200	125.82	124.89																																																																																																																																																																																																																																																																																																																																																																																																																																																										
190	125.85	124.92																																																																																																																																																																																																																																																																																																																																																																																																																																																										
180	125.88	124.95																																																																																																																																																																																																																																																																																																																																																																																																																																																										
170	125.91	124.98																																																																																																																																																																																																																																																																																																																																																																																																																																																										
160	125.94	125.01																																																																																																																																																																																																																																																																																																																																																																																																																																																										
150	125.97	125.04																																																																																																																																																																																																																																																																																																																																																																																																																																																										
140	125.99	125.07																																																																																																																																																																																																																																																																																																																																																																																																																																																										
130	126.02	125.10																																																																																																																																																																																																																																																																																																																																																																																																																																																										
120	126.05	125.13																																																																																																																																																																																																																																																																																																																																																																																																																																																										
110	126.08	125.16																																																																																																																																																																																																																																																																																																																																																																																																																																																										
100	126.11	125.19																																																																																																																																																																																																																																																																																																																																																																																																																																																										
90	126.14	125.22																																																																																																																																																																																																																																																																																																																																																																																																																																																										
80	126.17	125.25																																																																																																																																																																																																																																																																																																																																																																																																																																																										
70	126.20	125.28																																																																																																																																																																																																																																																																																																																																																																																																																																																										
60	126.23	125.31																																																																																																																																																																																																																																																																																																																																																																																																																																																										
50	126.26	125.34																																																																																																																																																																																																																																																																																																																																																																																																																																																										
40	126.29	125.37																																																																																																																																																																																																																																																																																																																																																																																																																																																										
30	126.32	125.40																																																																																																																																																																																																																																																																																																																																																																																																																																																										
20	126.35	125.43																																																																																																																																																																																																																																																																																																																																																																																																																																																										
10	126.38	125.46																																																																																																																																																																																																																																																																																																																																																																																																																																																										
0	126.41	125.49																																																																																																																																																																																																																																																																																																																																																																																																																																																										
<table border="1"> <tr><td>123.00</td><td>122.07</td></tr> <tr><td>123.03</td><td>122.10</td></tr> <tr><td>123.06</td><td>122.13</td></tr> <tr><td>123.09</td><td>122.16</td></tr> <tr><td>123.12</td><td>122.19</td></tr> <tr><td>123.15</td><td>122.22</td></tr> <tr><td>123.18</td><td>122.25</td></tr> <tr><td>123.21</td><td>122.28</td></tr> <tr><td>123.24</td><td>122.31</td></tr> <tr><td>123.27</td><td>122.34</td></tr> <tr><td>123.30</td><td>122.37</td></tr> <tr><td>123.33</td><td>122.40</td></tr> <tr><td>123.36</td><td>122.43</td></tr> <tr><td>123.39</td><td>122.46</td></tr> <tr><td>123.42</td><td>122.49</td></tr> <tr><td>123.45</td><td>122.52</td></tr> <tr><td>123.48</td><td>122.55</td></tr> <tr><td>123.51</td><td>122.58</td></tr> <tr><td>123.54</td><td>122.61</td></tr> <tr><td>123.57</td><td>122.64</td></tr> <tr><td>123.60</td><td>122.67</td></tr> <tr><td>123.63</td><td>122.70</td></tr> <tr><td>123.66</td><td>122.73</td></tr> <tr><td>123.69</td><td>122.76</td></tr> <tr><td>123.72</td><td>122.79</td></tr> <tr><td>123.75</td><td>122.82</td></tr> <tr><td>123.78</td><td>122.85</td></tr> <tr><td>123.81</td><td>122.88</td></tr> <tr><td>123.84</td><td>122.91</td></tr> <tr><td>123.87</td><td>122.94</td></tr> <tr><td>123.90</td><td>122.97</td></tr> <tr><td>123.93</td><td>123.00</td></tr> <tr><td>123.96</td><td>123.03</td></tr> <tr><td>123.99</td><td>123.06</td></tr> <tr><td>124.02</td><td>123.09</td></tr> <tr><td>124.05</td><td>123.12</td></tr> <tr><td>124.08</td><td>123.15</td></tr> <tr><td>124.11</td><td>123.18</td></tr> <tr><td>124.14</td><td>123.21</td></tr> <tr><td>124.17</td><td>123.24</td></tr> <tr><td>124.20</td><td>123.27</td></tr> <tr><td>124.23</td><td>123.30</td></tr> <tr><td>124.26</td><td>123.33</td></tr> <tr><td>124.29</td><td>123.36</td></tr> <tr><td>124.32</td><td>123.39</td></tr> <tr><td>124.35</td><td>123.42</td></tr> <tr><td>124.38</td><td>123.45</td></tr> <tr><td>124.41</td><td>123.48</td></tr> <tr><td>124.44</td><td>123.51</td></tr> <tr><td>124.47</td><td>123.54</td></tr> <tr><td>124.50</td><td>123.57</td></tr> <tr><td>124.53</td><td>123.60</td></tr> <tr><td>124.56</td><td>123.63</td></tr> <tr><td>124.59</td><td>123.66</td></tr> <tr><td>124.62</td><td>123.69</td></tr> <tr><td>124.65</td><td>123.72</td></tr> <tr><td>124.68</td><td>123.75</td></tr> <tr><td>124.71</td><td>123.78</td></tr> <tr><td>124.74</td><td>123.81</td></tr> <tr><td>124.77</td><td>123.84</td></tr> <tr><td>124.80</td><td>123.87</td></tr> <tr><td>124.83</td><td>123.90</td></tr> <tr><td>124.86</td><td>123.93</td></tr> <tr><td>124.89</td><td>123.96</td></tr> <tr><td>124.92</td><td>123.99</td></tr> <tr><td>124.95</td><td>124.02</td></tr> <tr><td>124.98</td><td>124.05</td></tr> <tr><td>125.01</td><td>124.08</td></tr> <tr><td>125.04</td><td>124.11</td></tr> <tr><td>125.07</td><td>124.14</td></tr> <tr><td>125.10</td><td>124.17</td></tr> <tr><td>125.13</td><td>124.20</td></tr> <tr><td>125.16</td><td>124.23</td></tr> <tr><td>125.19</td><td>124.26</td></tr> <tr><td>125.22</td><td>124.29</td></tr> <tr><td>125.25</td><td>124.32</td></tr> <tr><td>125.28</td><td>124.35</td></tr> <tr><td>125.31</td><td>124.38</td></tr> <tr><td>125.34</td><td>124.41</td></tr> <tr><td>125.37</td><td>124.44</td></tr> <tr><td>125.40</td><td>124.47</td></tr> <tr><td>125.43</td><td>124.50</td></tr> <tr><td>125.46</td><td>124.53</td></tr> <tr><td>125.49</td><td>124.56</td></tr> <tr><td>125.52</td><td>124.59</td></tr> <tr><td>125.55</td><td>124.62</td></tr> <tr><td>125.58</td><td>124.65</td></tr> <tr><td>125.61</td><td>124.68</td></tr> <tr><td>125.64</td><td>124.71</td></tr> <tr><td>125.67</td><td>124.74</td></tr> <tr><td>125.70</td><td>124.77</td></tr> <tr><td>125.73</td><td>124.80</td></tr> <tr><td>125.76</td><td>124.83</td></tr> <tr><td>125.79</td><td>124.86</td></tr> <tr><td>125.82</td><td>124.89</td></tr> <tr><td>125.85</td><td>124.92</td></tr> <tr><td>125.88</td><td>124.95</td></tr> <tr><td>125.91</td><td>124.98</td></tr> <tr><td>125.94</td><td>125.01</td></tr> <tr><td>125.97</td><td>125.04</td></tr> <tr><td>126.00</td><td>125.07</td></tr> <tr><td>126.03</td><td>125.10</td></tr> <tr><td>126.06</td><td>125.13</td></tr> <tr><td>126.09</td><td>125.16</td></tr> <tr><td>126.12</td><td>125.19</td></tr> <tr><td>126.15</td><td>125.22</td></tr> <tr><td>126.18</td><td>125.25</td></tr> <tr><td>126.21</td><td>125.28</td></tr> <tr><td>126.24</td><td>125.31</td></tr> <tr><td>126.27</td><td>125.34</td></tr> <tr><td>126.30</td><td>125.37</td></tr> <tr><td>126.33</td><td>125.40</td></tr> <tr><td>126.36</td><td>125.43</td></tr> <tr><td>126.39</td><td>125.46</td></tr> <tr><td>126.42</td><td>125.49</td></tr> <tr><td>126.45</td><td>125.52</td></tr> <tr><td>126.48</td><td>125.55</td></tr> <tr><td>126.51</td><td>125.58</td></tr> <tr><td>126.54</td><td>125.61</td></tr> <tr><td>126.57</td><td>125.64</td></tr> <tr><td>126.60</td><td>125.67</td></tr> <tr><td>126.63</td><td>125.70</td></tr> <tr><td>126.66</td><td>125.73</td></tr> <tr><td>126.69</td><td>125.76</td></tr> <tr><td>126.72</td><td>125.79</td></tr> <tr><td>126.75</td><td>125.82</td></tr> <tr><td>126.78</td><td>125.85</td></tr> <tr><td>126.81</td><td>125.88</td></tr> <tr><td>126.84</td><td>125.91</td></tr> <tr><td>126.87</td><td>125.94</td></tr> <tr><td>126.90</td><td>125.97</td></tr> <tr><td>126.93</td><td>126.00</td></tr> <tr><td>126.96</td><td>126.03</td></tr> <tr><td>126.99</td><td>126.06</td></tr> <tr><td>127.02</td><td>126.09</td></tr> <tr><td>127.05</td><td>126.12</td></tr> <tr><td>127.08</td><td>126.15</td></tr> <tr><td>127.11</td><td>126.18</td></tr> <tr><td>127.14</td><td>126.21</td></tr> <tr><td>127.17</td><td>126.24</td></tr> <tr><td>127.20</td><td>126.27</td></tr> <tr><td>127.23</td><td>126.30</td></tr> <tr><td>127.26</td><td>126.33</td></tr> <tr><td>127.29</td><td>126.36</td></tr> <tr><td>127.32</td><td>126.39</td></tr> <tr><td>127.35</td><td>126.42</td></tr> <tr><td>127.38</td><td>126.45</td></tr> <tr><td>127.41</td><td>126.48</td></tr> <tr><td>127.44</td><td>126.51</td></tr> <tr><td>127.47</td><td>126.54</td></tr> <tr><td>127.50</td><td>126.57</td></tr> <tr><td>127.53</td><td>126.60</td></tr> <tr><td>127.56</td><td>126.63</td></tr> <tr><td>127.59</td><td>126.66</td></tr> <tr><td>127.62</td><td>126.69</td></tr> <tr><td>127.65</td><td>126.72</td></tr> <tr><td>127.68</td><td>126.75</td></tr> <tr><td>127.71</td><td>126.78</td></tr> <tr><td>127.74</td><td>126.81</td></tr> <tr><td>127.77</td><td>126.84</td></tr> <tr><td>127.80</td><td>126.87</td></tr> <tr><td>127.83</td><td>126.90</td></tr> <tr><td>127.86</td><td>126.93</td></tr> <tr><td>127.89</td><td>126.96</td></tr> <tr><td>127.92</td><td>126.99</td></tr> <tr><td>127.95</td><td>127.02</td></tr> <tr><td>127.98</td><td>127.05</td></tr> <tr><td>128.01</td><td>127.08</td></tr> <tr><td>128.04</td><td>127.11</td></tr> <tr><td>128.07</td><td>127.14</td></tr> <tr><td>128.10</td><td>127.17</td></tr> <tr><td>128.13</td><td>127.20</td></tr> <tr><td>128.16</td><td>127.23</td></tr> <tr><td>128.19</td><td>127.26</td></tr> <tr><td>128.22</td><td>127.29</td></tr> <tr><td>128.25</td><td>127.32</td></tr> <tr><td>128.28</td><td>127.35</td></tr> <tr><td>128.31</td><td>127.38</td></tr> <tr><td>128.34</td><td>127.41</td></tr> <tr><td>128.37</td><td>127.44</td></tr> <tr><td>128.40</td><td>127.47</td></tr> <tr><td>128.43</td><td>127.50</td></tr> <tr><td>128.46</td><td>127.53</td></tr> <tr><td>128.49</td><td>127.56</td></tr> <tr><td>128.52</td><td>127.59</td></tr> <tr><td>128.55</td><td>127.62</td></tr> <tr><td>128.58</td><td>127.65</td></tr> <tr><td>128.61</td><td>127.68</td></tr> <tr><td>128.64</td><td>127.71</td></tr> <tr><td>128.67</td><td>127.74</td></tr> <tr><td>128.70</td><td>127.77</td></tr> <tr><td>128.73</td><td>127.80</td></tr> <tr><td>128.76</td><td>127.83</td></tr> <tr><td>128.79</td><td>127.86</td></tr> <tr><td>128.82</td><td>127.89</td></tr> <tr><td>128.85</td><td>127.92</td></tr> <tr><td>128.88</td><td>127.95</td></tr> <tr><td>128.91</td><td>127.98</td></tr> <tr><td>128.94</td><td>128.01</td></tr> <tr><td>128.97</td><td>128.04</td></tr> <tr><td>129.00</td><td>128.07</td></tr> <tr><td>129.03</td><td>128.10</td></tr> <tr><td>129.06</td><td>128.13</td></tr> <tr><td>129.09</td><td>128.16</td></tr> <tr><td>129.12</td><td>128.19</td></tr> <tr><td>129.15</td><td>128.22</td></tr> <tr><td>129.18</td><td>128.25</td></tr> <tr><td>129.21</td><td>128.28</td></tr> <tr><td>129.24</td><td>128.31</td></tr> <tr><td>129.27</td><td>128.34</td></tr> <tr><td>129.30</td><td>128.37</td></tr> <tr><td>129.33</td><td>128.40</td></tr> <tr><td>129.36</td><td>128.43</td></tr> <tr><td>129.39</td><td>128.46</td></tr> <tr><td>129.42</td><td>128.49</td></tr> <tr><td>129.45</td><td>128.52</td></tr> <tr><td>129.48</td><td>128.55</td></tr> <tr><td>129.51</td><td>128.58</td></tr> <tr><td>129.54</td><td>128.61</td></tr> <tr><td>129.57</td><td>128.64</td></tr> <tr><td>129.60</td><td>128.67</td></tr></table>			123.00	122.07	123.03	122.10	123.06	122.13	123.09	122.16	123.12	122.19	123.15	122.22	123.18	122.25	123.21	122.28	123.24	122.31	123.27	122.34	123.30	122.37	123.33	122.40	123.36	122.43	123.39	122.46	123.42	122.49	123.45	122.52	123.48	122.55	123.51	122.58	123.54	122.61	123.57	122.64	123.60	122.67	123.63	122.70	123.66	122.73	123.69	122.76	123.72	122.79	123.75	122.82	123.78	122.85	123.81	122.88	123.84	122.91	123.87	122.94	123.90	122.97	123.93	123.00	123.96	123.03	123.99	123.06	124.02	123.09	124.05	123.12	124.08	123.15	124.11	123.18	124.14	123.21	124.17	123.24	124.20	123.27	124.23	123.30	124.26	123.33	124.29	123.36	124.32	123.39	124.35	123.42	124.38	123.45	124.41	123.48	124.44	123.51	124.47	123.54	124.50	123.57	124.53	123.60	124.56	123.63	124.59	123.66	124.62	123.69	124.65	123.72	124.68	123.75	124.71	123.78	124.74	123.81	124.77	123.84	124.80	123.87	124.83	123.90	124.86	123.93	124.89	123.96	124.92	123.99	124.95	124.02	124.98	124.05	125.01	124.08	125.04	124.11	125.07	124.14	125.10	124.17	125.13	124.20	125.16	124.23	125.19	124.26	125.22	124.29	125.25	124.32	125.28	124.35	125.31	124.38	125.34	124.41	125.37	124.44	125.40	124.47	125.43	124.50	125.46	124.53	125.49	124.56	125.52	124.59	125.55	124.62	125.58	124.65	125.61	124.68	125.64	124.71	125.67	124.74	125.70	124.77	125.73	124.80	125.76	124.83	125.79	124.86	125.82	124.89	125.85	124.92	125.88	124.95	125.91	124.98	125.94	125.01	125.97	125.04	126.00	125.07	126.03	125.10	126.06	125.13	126.09	125.16	126.12	125.19	126.15	125.22	126.18	125.25	126.21	125.28	126.24	125.31	126.27	125.34	126.30	125.37	126.33	125.40	126.36	125.43	126.39	125.46	126.42	125.49	126.45	125.52	126.48	125.55	126.51	125.58	126.54	125.61	126.57	125.64	126.60	125.67	126.63	125.70	126.66	125.73	126.69	125.76	126.72	125.79	126.75	125.82	126.78	125.85	126.81	125.88	126.84	125.91	126.87	125.94	126.90	125.97	126.93	126.00	126.96	126.03	126.99	126.06	127.02	126.09	127.05	126.12	127.08	126.15	127.11	126.18	127.14	126.21	127.17	126.24	127.20	126.27	127.23	126.30	127.26	126.33	127.29	126.36	127.32	126.39	127.35	126.42	127.38	126.45	127.41	126.48	127.44	126.51	127.47	126.54	127.50	126.57	127.53	126.60	127.56	126.63	127.59	126.66	127.62	126.69	127.65	126.72	127.68	126.75	127.71	126.78	127.74	126.81	127.77	126.84	127.80	126.87	127.83	126.90	127.86	126.93	127.89	126.96	127.92	126.99	127.95	127.02	127.98	127.05	128.01	127.08	128.04	127.11	128.07	127.14	128.10	127.17	128.13	127.20	128.16	127.23	128.19	127.26	128.22	127.29	128.25	127.32	128.28	127.35	128.31	127.38	128.34	127.41	128.37	127.44	128.40	127.47	128.43	127.50	128.46	127.53	128.49	127.56	128.52	127.59	128.55	127.62	128.58	127.65	128.61	127.68	128.64	127.71	128.67	127.74	128.70	127.77	128.73	127.80	128.76	127.83	128.79	127.86	128.82	127.89	128.85	127.92	128.88	127.95	128.91	127.98	128.94	128.01	128.97	128.04	129.00	128.07	129.03	128.10	129.06	128.13	129.09	128.16	129.12	128.19	129.15	128.22	129.18	128.25	129.21	128.28	129.24	128.31	129.27	128.34	129.30	128.37	129.33	128.40	129.36	128.43	129.39	128.46	129.42	128.49	129.45	128.52	129.48	128.55	129.51	128.58	129.54	128.61	129.57	128.64	129.60	128.67
123.00	122.07																																																																																																																																																																																																																																																																																																																																																																																																																																																											
123.03	122.10																																																																																																																																																																																																																																																																																																																																																																																																																																																											
123.06	122.13																																																																																																																																																																																																																																																																																																																																																																																																																																																											
123.09	122.16																																																																																																																																																																																																																																																																																																																																																																																																																																																											
123.12	122.19																																																																																																																																																																																																																																																																																																																																																																																																																																																											
123.15	122.22																																																																																																																																																																																																																																																																																																																																																																																																																																																											
123.18	122.25																																																																																																																																																																																																																																																																																																																																																																																																																																																											
123.21	122.28																																																																																																																																																																																																																																																																																																																																																																																																																																																											
123.24	122.31																																																																																																																																																																																																																																																																																																																																																																																																																																																											
123.27	122.34																																																																																																																																																																																																																																																																																																																																																																																																																																																											
123.30	122.37																																																																																																																																																																																																																																																																																																																																																																																																																																																											
123.33	122.40																																																																																																																																																																																																																																																																																																																																																																																																																																																											
123.36	122.43																																																																																																																																																																																																																																																																																																																																																																																																																																																											
123.39	122.46																																																																																																																																																																																																																																																																																																																																																																																																																																																											
123.42	122.49																																																																																																																																																																																																																																																																																																																																																																																																																																																											
123.45	122.52																																																																																																																																																																																																																																																																																																																																																																																																																																																											
123.48	122.55																																																																																																																																																																																																																																																																																																																																																																																																																																																											
123.51	122.58																																																																																																																																																																																																																																																																																																																																																																																																																																																											
123.54	122.61																																																																																																																																																																																																																																																																																																																																																																																																																																																											
123.57	122.64																																																																																																																																																																																																																																																																																																																																																																																																																																																											
123.60	122.67																																																																																																																																																																																																																																																																																																																																																																																																																																																											
123.63	122.70																																																																																																																																																																																																																																																																																																																																																																																																																																																											
123.66	122.73																																																																																																																																																																																																																																																																																																																																																																																																																																																											
123.69	122.76																																																																																																																																																																																																																																																																																																																																																																																																																																																											
123.72	122.79																																																																																																																																																																																																																																																																																																																																																																																																																																																											
123.75	122.82																																																																																																																																																																																																																																																																																																																																																																																																																																																											
123.78	122.85																																																																																																																																																																																																																																																																																																																																																																																																																																																											
123.81	122.88																																																																																																																																																																																																																																																																																																																																																																																																																																																											
123.84	122.91																																																																																																																																																																																																																																																																																																																																																																																																																																																											
123.87	122.94																																																																																																																																																																																																																																																																																																																																																																																																																																																											
123.90	122.97																																																																																																																																																																																																																																																																																																																																																																																																																																																											
123.93	123.00																																																																																																																																																																																																																																																																																																																																																																																																																																																											
123.96	123.03																																																																																																																																																																																																																																																																																																																																																																																																																																																											
123.99	123.06																																																																																																																																																																																																																																																																																																																																																																																																																																																											
124.02	123.09																																																																																																																																																																																																																																																																																																																																																																																																																																																											
124.05	123.12																																																																																																																																																																																																																																																																																																																																																																																																																																																											
124.08	123.15																																																																																																																																																																																																																																																																																																																																																																																																																																																											
124.11	123.18																																																																																																																																																																																																																																																																																																																																																																																																																																																											
124.14	123.21																																																																																																																																																																																																																																																																																																																																																																																																																																																											
124.17	123.24																																																																																																																																																																																																																																																																																																																																																																																																																																																											
124.20	123.27																																																																																																																																																																																																																																																																																																																																																																																																																																																											
124.23	123.30																																																																																																																																																																																																																																																																																																																																																																																																																																																											
124.26	123.33																																																																																																																																																																																																																																																																																																																																																																																																																																																											
124.29	123.36																																																																																																																																																																																																																																																																																																																																																																																																																																																											
124.32	123.39																																																																																																																																																																																																																																																																																																																																																																																																																																																											
124.35	123.42																																																																																																																																																																																																																																																																																																																																																																																																																																																											
124.38	123.45																																																																																																																																																																																																																																																																																																																																																																																																																																																											
124.41	123.48																																																																																																																																																																																																																																																																																																																																																																																																																																																											
124.44	123.51																																																																																																																																																																																																																																																																																																																																																																																																																																																											
124.47	123.54																																																																																																																																																																																																																																																																																																																																																																																																																																																											
124.50	123.57																																																																																																																																																																																																																																																																																																																																																																																																																																																											
124.53	123.60																																																																																																																																																																																																																																																																																																																																																																																																																																																											
124.56	123.63																																																																																																																																																																																																																																																																																																																																																																																																																																																											
124.59	123.66																																																																																																																																																																																																																																																																																																																																																																																																																																																											
124.62	123.69																																																																																																																																																																																																																																																																																																																																																																																																																																																											
124.65	123.72																																																																																																																																																																																																																																																																																																																																																																																																																																																											
124.68	123.75																																																																																																																																																																																																																																																																																																																																																																																																																																																											
124.71	123.78																																																																																																																																																																																																																																																																																																																																																																																																																																																											
124.74	123.81																																																																																																																																																																																																																																																																																																																																																																																																																																																											
124.77	123.84																																																																																																																																																																																																																																																																																																																																																																																																																																																											
124.80	123.87																																																																																																																																																																																																																																																																																																																																																																																																																																																											
124.83	123.90																																																																																																																																																																																																																																																																																																																																																																																																																																																											
124.86	123.93																																																																																																																																																																																																																																																																																																																																																																																																																																																											
124.89	123.96																																																																																																																																																																																																																																																																																																																																																																																																																																																											
124.92	123.99																																																																																																																																																																																																																																																																																																																																																																																																																																																											
124.95	124.02																																																																																																																																																																																																																																																																																																																																																																																																																																																											
124.98	124.05																																																																																																																																																																																																																																																																																																																																																																																																																																																											
125.01	124.08																																																																																																																																																																																																																																																																																																																																																																																																																																																											
125.04	124.11																																																																																																																																																																																																																																																																																																																																																																																																																																																											
125.07	124.14																																																																																																																																																																																																																																																																																																																																																																																																																																																											
125.10	124.17																																																																																																																																																																																																																																																																																																																																																																																																																																																											
125.13	124.20																																																																																																																																																																																																																																																																																																																																																																																																																																																											
125.16	124.23																																																																																																																																																																																																																																																																																																																																																																																																																																																											
125.19	124.26																																																																																																																																																																																																																																																																																																																																																																																																																																																											
125.22	124.29																																																																																																																																																																																																																																																																																																																																																																																																																																																											
125.25	124.32																																																																																																																																																																																																																																																																																																																																																																																																																																																											
125.28	124.35																																																																																																																																																																																																																																																																																																																																																																																																																																																											
125.31	124.38																																																																																																																																																																																																																																																																																																																																																																																																																																																											
125.34	124.41																																																																																																																																																																																																																																																																																																																																																																																																																																																											
125.37	124.44																																																																																																																																																																																																																																																																																																																																																																																																																																																											
125.40	124.47																																																																																																																																																																																																																																																																																																																																																																																																																																																											
125.43	124.50																																																																																																																																																																																																																																																																																																																																																																																																																																																											
125.46	124.53																																																																																																																																																																																																																																																																																																																																																																																																																																																											
125.49	124.56																																																																																																																																																																																																																																																																																																																																																																																																																																																											
125.52	124.59																																																																																																																																																																																																																																																																																																																																																																																																																																																											
125.55	124.62																																																																																																																																																																																																																																																																																																																																																																																																																																																											
125.58	124.65																																																																																																																																																																																																																																																																																																																																																																																																																																																											
125.61	124.68																																																																																																																																																																																																																																																																																																																																																																																																																																																											
125.64	124.71																																																																																																																																																																																																																																																																																																																																																																																																																																																											
125.67	124.74																																																																																																																																																																																																																																																																																																																																																																																																																																																											
125.70	124.77																																																																																																																																																																																																																																																																																																																																																																																																																																																											
125.73	124.80																																																																																																																																																																																																																																																																																																																																																																																																																																																											
125.76	124.83																																																																																																																																																																																																																																																																																																																																																																																																																																																											
125.79	124.86																																																																																																																																																																																																																																																																																																																																																																																																																																																											
125.82	124.89																																																																																																																																																																																																																																																																																																																																																																																																																																																											
125.85	124.92																																																																																																																																																																																																																																																																																																																																																																																																																																																											
125.88	124.95																																																																																																																																																																																																																																																																																																																																																																																																																																																											
125.91	124.98																																																																																																																																																																																																																																																																																																																																																																																																																																																											
125.94	125.01																																																																																																																																																																																																																																																																																																																																																																																																																																																											
125.97	125.04																																																																																																																																																																																																																																																																																																																																																																																																																																																											
126.00	125.07																																																																																																																																																																																																																																																																																																																																																																																																																																																											
126.03	125.10																																																																																																																																																																																																																																																																																																																																																																																																																																																											
126.06	125.13																																																																																																																																																																																																																																																																																																																																																																																																																																																											
126.09	125.16																																																																																																																																																																																																																																																																																																																																																																																																																																																											
126.12	125.19																																																																																																																																																																																																																																																																																																																																																																																																																																																											
126.15	125.22																																																																																																																																																																																																																																																																																																																																																																																																																																																											
126.18	125.25																																																																																																																																																																																																																																																																																																																																																																																																																																																											
126.21	125.28																																																																																																																																																																																																																																																																																																																																																																																																																																																											
126.24	125.31																																																																																																																																																																																																																																																																																																																																																																																																																																																											
126.27	125.34																																																																																																																																																																																																																																																																																																																																																																																																																																																											
126.30	125.37																																																																																																																																																																																																																																																																																																																																																																																																																																																											
126.33	125.40																																																																																																																																																																																																																																																																																																																																																																																																																																																											
126.36	125.43																																																																																																																																																																																																																																																																																																																																																																																																																																																											
126.39	125.46																																																																																																																																																																																																																																																																																																																																																																																																																																																											
126.42	125.49																																																																																																																																																																																																																																																																																																																																																																																																																																																											
126.45	125.52																																																																																																																																																																																																																																																																																																																																																																																																																																																											
126.48	125.55																																																																																																																																																																																																																																																																																																																																																																																																																																																											
126.51	125.58																																																																																																																																																																																																																																																																																																																																																																																																																																																											
126.54	125.61																																																																																																																																																																																																																																																																																																																																																																																																																																																											
126.57	125.64																																																																																																																																																																																																																																																																																																																																																																																																																																																											
126.60	125.67																																																																																																																																																																																																																																																																																																																																																																																																																																																											
126.63	125.70																																																																																																																																																																																																																																																																																																																																																																																																																																																											
126.66	125.73																																																																																																																																																																																																																																																																																																																																																																																																																																																											
126.69	125.76																																																																																																																																																																																																																																																																																																																																																																																																																																																											
126.72	125.79																																																																																																																																																																																																																																																																																																																																																																																																																																																											
126.75	125.82																																																																																																																																																																																																																																																																																																																																																																																																																																																											
126.78	125.85																																																																																																																																																																																																																																																																																																																																																																																																																																																											
126.81	125.88																																																																																																																																																																																																																																																																																																																																																																																																																																																											
126.84	125.91																																																																																																																																																																																																																																																																																																																																																																																																																																																											
126.87	125.94																																																																																																																																																																																																																																																																																																																																																																																																																																																											
126.90	125.97																																																																																																																																																																																																																																																																																																																																																																																																																																																											
126.93	126.00																																																																																																																																																																																																																																																																																																																																																																																																																																																											
126.96	126.03																																																																																																																																																																																																																																																																																																																																																																																																																																																											
126.99	126.06																																																																																																																																																																																																																																																																																																																																																																																																																																																											
127.02	126.09																																																																																																																																																																																																																																																																																																																																																																																																																																																											
127.05	126.12																																																																																																																																																																																																																																																																																																																																																																																																																																																											
127.08	126.15																																																																																																																																																																																																																																																																																																																																																																																																																																																											
127.11	126.18																																																																																																																																																																																																																																																																																																																																																																																																																																																											
127.14	126.21																																																																																																																																																																																																																																																																																																																																																																																																																																																											
127.17	126.24																																																																																																																																																																																																																																																																																																																																																																																																																																																											
127.20	126.27																																																																																																																																																																																																																																																																																																																																																																																																																																																											
127.23	126.30																																																																																																																																																																																																																																																																																																																																																																																																																																																											
127.26	126.33																																																																																																																																																																																																																																																																																																																																																																																																																																																											
127.29	126.36																																																																																																																																																																																																																																																																																																																																																																																																																																																											
127.32	126.39																																																																																																																																																																																																																																																																																																																																																																																																																																																											
127.35	126.42																																																																																																																																																																																																																																																																																																																																																																																																																																																											
127.38	126.45																																																																																																																																																																																																																																																																																																																																																																																																																																																											
127.41	126.48																																																																																																																																																																																																																																																																																																																																																																																																																																																											
127.44	126.51																																																																																																																																																																																																																																																																																																																																																																																																																																																											
127.47	126.54																																																																																																																																																																																																																																																																																																																																																																																																																																																											
127.50	126.57																																																																																																																																																																																																																																																																																																																																																																																																																																																											
127.53	126.60																																																																																																																																																																																																																																																																																																																																																																																																																																																											
127.56	126.63																																																																																																																																																																																																																																																																																																																																																																																																																																																											
127.59	126.66																																																																																																																																																																																																																																																																																																																																																																																																																																																											
127.62	126.69																																																																																																																																																																																																																																																																																																																																																																																																																																																											
127.65	126.72																																																																																																																																																																																																																																																																																																																																																																																																																																																											
127.68	126.75																																																																																																																																																																																																																																																																																																																																																																																																																																																											
127.71	126.78																																																																																																																																																																																																																																																																																																																																																																																																																																																											
127.74	126.81																																																																																																																																																																																																																																																																																																																																																																																																																																																											
127.77	126.84																																																																																																																																																																																																																																																																																																																																																																																																																																																											
127.80	126.87																																																																																																																																																																																																																																																																																																																																																																																																																																																											
127.83	126.90																																																																																																																																																																																																																																																																																																																																																																																																																																																											
127.86	126.93																																																																																																																																																																																																																																																																																																																																																																																																																																																											
127.89	126.96																																																																																																																																																																																																																																																																																																																																																																																																																																																											
127.92	126.99																																																																																																																																																																																																																																																																																																																																																																																																																																																											
127.95	127.02																																																																																																																																																																																																																																																																																																																																																																																																																																																											
127.98	127.05																																																																																																																																																																																																																																																																																																																																																																																																																																																											
128.01	127.08																																																																																																																																																																																																																																																																																																																																																																																																																																																											
128.04	127.11																																																																																																																																																																																																																																																																																																																																																																																																																																																											
128.07	127.14																																																																																																																																																																																																																																																																																																																																																																																																																																																											
128.10	127.17																																																																																																																																																																																																																																																																																																																																																																																																																																																											
128.13	127.20																																																																																																																																																																																																																																																																																																																																																																																																																																																											
128.16	127.23																																																																																																																																																																																																																																																																																																																																																																																																																																																											
128.19	127.26																																																																																																																																																																																																																																																																																																																																																																																																																																																											
128.22	127.29																																																																																																																																																																																																																																																																																																																																																																																																																																																											
128.25	127.32																																																																																																																																																																																																																																																																																																																																																																																																																																																											
128.28	127.35																																																																																																																																																																																																																																																																																																																																																																																																																																																											
128.31	127.38																																																																																																																																																																																																																																																																																																																																																																																																																																																											
128.34	127.41																																																																																																																																																																																																																																																																																																																																																																																																																																																											
128.37	127.44																																																																																																																																																																																																																																																																																																																																																																																																																																																											
128.40	127.47																																																																																																																																																																																																																																																																																																																																																																																																																																																											
128.43	127.50																																																																																																																																																																																																																																																																																																																																																																																																																																																											
128.46	127.53																																																																																																																																																																																																																																																																																																																																																																																																																																																											
128.49	127.56																																																																																																																																																																																																																																																																																																																																																																																																																																																											
128.52	127.59																																																																																																																																																																																																																																																																																																																																																																																																																																																											
128.55	127.62																																																																																																																																																																																																																																																																																																																																																																																																																																																											
128.58	127.65																																																																																																																																																																																																																																																																																																																																																																																																																																																											
128.61	127.68																																																																																																																																																																																																																																																																																																																																																																																																																																																											
128.64	127.71																																																																																																																																																																																																																																																																																																																																																																																																																																																											
128.67	127.74																																																																																																																																																																																																																																																																																																																																																																																																																																																											
128.70	127.77																																																																																																																																																																																																																																																																																																																																																																																																																																																											
128.73	127.80																																																																																																																																																																																																																																																																																																																																																																																																																																																											
128.76	127.83																																																																																																																																																																																																																																																																																																																																																																																																																																																											
128.79	127.86																																																																																																																																																																																																																																																																																																																																																																																																																																																											
128.82	127.89																																																																																																																																																																																																																																																																																																																																																																																																																																																											
128.85	127.92																																																																																																																																																																																																																																																																																																																																																																																																																																																											
128.88	127.95																																																																																																																																																																																																																																																																																																																																																																																																																																																											
128.91	127.98																																																																																																																																																																																																																																																																																																																																																																																																																																																											
128.94	128.01																																																																																																																																																																																																																																																																																																																																																																																																																																																											
128.97	128.04																																																																																																																																																																																																																																																																																																																																																																																																																																																											
129.00	128.07																																																																																																																																																																																																																																																																																																																																																																																																																																																											
129.03	128.10																																																																																																																																																																																																																																																																																																																																																																																																																																																											
129.06	128.13																																																																																																																																																																																																																																																																																																																																																																																																																																																											
129.09	128.16																																																																																																																																																																																																																																																																																																																																																																																																																																																											
129.12	128.19																																																																																																																																																																																																																																																																																																																																																																																																																																																											
129.15	128.22																																																																																																																																																																																																																																																																																																																																																																																																																																																											
129.18	128.25																																																																																																																																																																																																																																																																																																																																																																																																																																																											
129.21	128.28																																																																																																																																																																																																																																																																																																																																																																																																																																																											
129.24	128.31																																																																																																																																																																																																																																																																																																																																																																																																																																																											
129.27	128.34																																																																																																																																																																																																																																																																																																																																																																																																																																																											
129.30	128.37																																																																																																																																																																																																																																																																																																																																																																																																																																																											
129.33	128.40																																																																																																																																																																																																																																																																																																																																																																																																																																																											
129.36	128.43																																																																																																																																																																																																																																																																																																																																																																																																																																																											
129.39	128.46																																																																																																																																																																																																																																																																																																																																																																																																																																																											
129.42	128.49																																																																																																																																																																																																																																																																																																																																																																																																																																																											
129.45	128.52																																																																																																																																																																																																																																																																																																																																																																																																																																																											
129.48	128.55																																																																																																																																																																																																																																																																																																																																																																																																																																																											
129.51	128.58																																																																																																																																																																																																																																																																																																																																																																																																																																																											
129.54	128.61																																																																																																																																																																																																																																																																																																																																																																																																																																																											
129.57	128.64																																																																																																																																																																																																																																																																																																																																																																																																																																																											
129.60	128.67																																																																																																																																																																																																																																																																																																																																																																																																																																																											

110 mm skersmens polietileninės drenažo žiotys

PLANAS, PJŪVIAI, MAZGAS

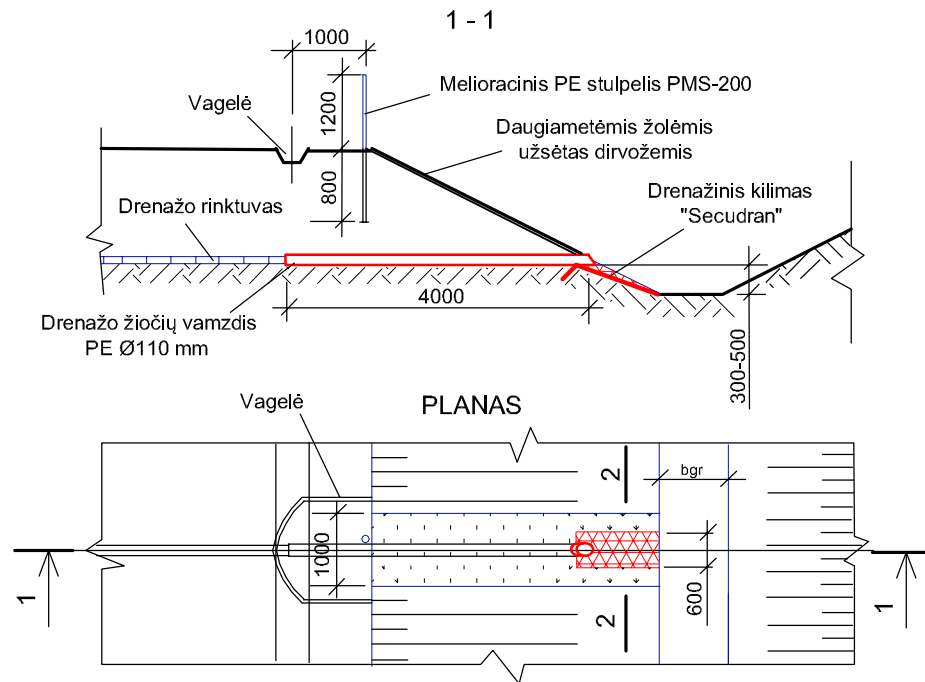

IŠTEKĖJIMO IŠ ŽIOČIŲ VAMZDŽIO MAZGAS

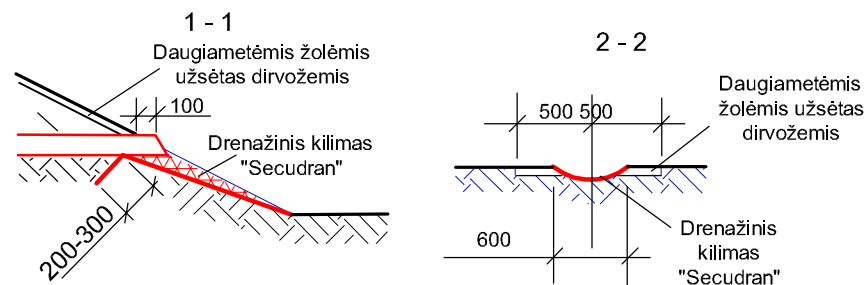

PASTABOS: 1. Drenažinis kilimas "Secudran" tvirtinamas prikalandant vielos Ø 5 mm, L 500 mm smaigais;
2. Rinktuvo vamzdžių ir žiočių sandūra sandarinama ritinine filtracine medžiaga.

DARBŲ SUDĖTIS, DARBO SANAUDOS IR MATERIALINIAI RESURSAI KEIČIANT ESAMAS ŽIOTIS

DARBŲ SUDĖTIS

1. Žiočių atkasimas ir išėmimas rankiniu būdu. 2. Rinktuvų atkasimas vienkaušiais ekskavatoriais. 3. Keraminių vamzdžių išėmimas. 4. Tranšėjų dugno paruošimas rankiniu būdu. 5. Polietileninių žiočių paklojimas. 6. Sujungimų užsandarinimas. 7. Drenažo žiočių pirminis užpylimas, sutankinant gruntą. 8. Tranšėjų užpylimas buldozeriu. 9. Šlaitų išlyginimas. 10. Tvirtinimo medžiagos paruošimas ir paklojimas. Drenažinio kilimo pritvirtinimas metaliniais smeigais. 12. Šlaito užpylimas dirvožemiu. 13. Trašų išbėrimas. 14. Daugiamečių žolių užsėjimas. 15. Stulpelio PMS-200 pastatymas. 16. Plastikinių apsauginių grotelių įrengimas. 17. Išardytų sulūžusių drenažo žiočių išvežimas.

DARBO SANAUDOS IR MATERIALINIAI RESURSAI

Kodas	Darbų, mechanizmų, medžiagų ir gaminių pavadinimas	Resurso kiekis, mato vnt.
MN7P-0205	Drenažo žiočių keitimas 110, kai drenažo žiočių skersmuo 110 mm	1 vnt.
	Darbo sąnaudos: Vid. kategorijos 3,27 darbo sąnaudos	10,1 žm. val.
320034 340013	Mechanizmai: Vienkaušiai ekskavatoriai su iki 0,4 m³ talpos kaušais Buldozeriai iki 59 kW (80 AJ) galingumo	1,60 maš. val. 0,84 maš. val.
900010 900082 120002 900069 900099 900072 900013	Medžiagos: Drenažo žiotys PE 110 mm skersmens Drenažo kilimas "Secudran R201 ES-601" Viela plieninė paprasta Dirvožemis Daugiamečių žolių sėklos Ritininė filtracinė medžiaga Melioracinis PE stulpelis PMS-200	1 vnt. 0,84 m² 0,70 kg 0,17 m³ 0,02 kg 0,30 m² 1 vnt.

0	2026	Laidos statusas. Keitimo priežastis (jei taikoma)	
Kval. patv. dok. Nr.			Lazdijų rajono savivaldybės Avižienių, Krosnos, Šeštokų ir Teizų kadastrinių vietovių dalių melioracijos statinių rekonstrukcija
S-757-Pm	SPV	A. Gegužis	Laida
			0
LT	Lazdijų rajono savivaldybė	GP - 26 - TDP - 01 - B.3	Lapas
			Lapaž
			1
			3

160 mm skersmens polietileninės drenažo žiotys

PLANAS, PJŪVIAI, MAZGAS

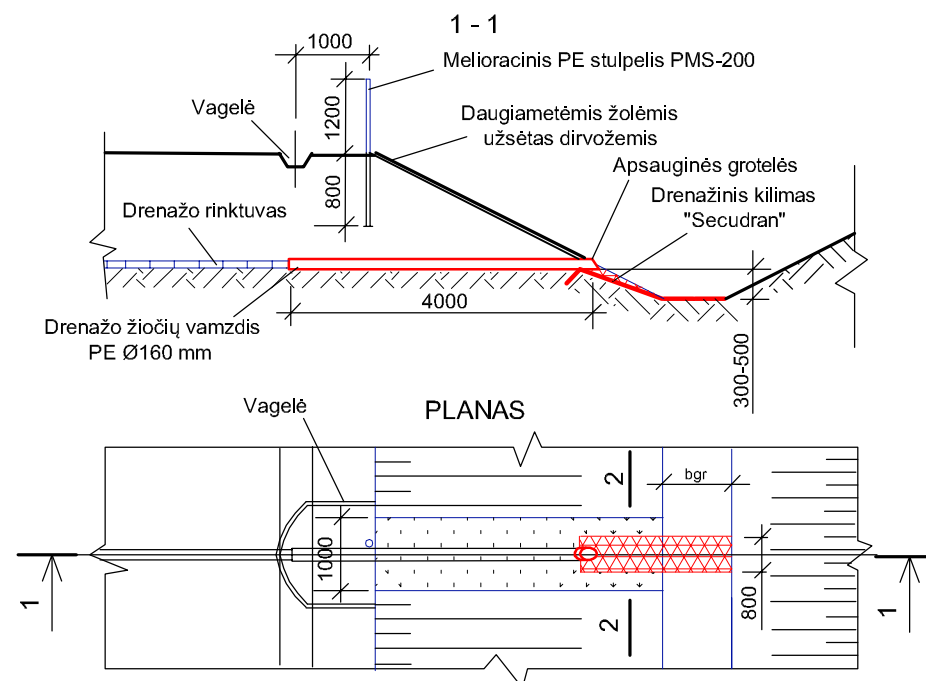

IŠTEKĖJIMO IŠ ŽIOČIŲ VAMZDŽIO MAZGAS

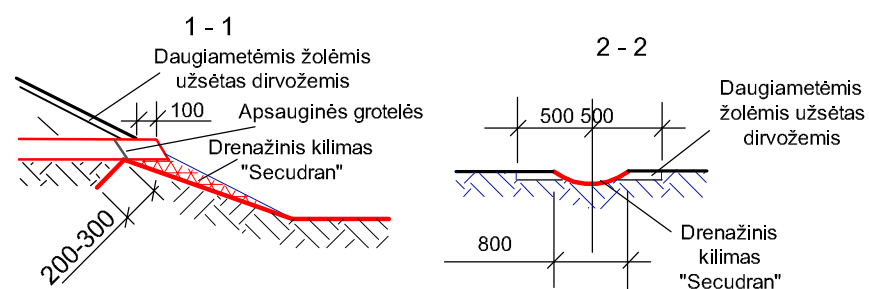

PASTABOS: 1. Drenažinis kilimas "Secudran" tvirtinamas prikalandant vielos \varnothing 5 mm, L 500 mm smaigais;
2. Rinktuvo vamzdžių ir žiočių sandūra sandarinama ritinine filtracine medžiaga.

DARBŲ SUDĖTIS, DARBO SANAUDOS IR MATERIALINIAI RESURSAI KEIČIANT ESAMAS ŽIOTIS

DARBŲ SUDĖTIS

1. Žiočių atkasimas ir išėmimas rankiniu būdu. 2. Rinktuvų atkasimas vienkaušiais ekskavatoriais. 3. Keraminių vamzdžių išėmimas. 4. Tranšėjų dugno paruošimas rankiniu būdu. 5. Polietilenu žiočių paklojimas. 6. Sujungimų užsandarinimas. 7. Drenažo žiočių pirminis užpylimas, sutankinant gruntą. 8. Tranšėjų užpylimas buldozeriu. 9. Šlaitų išlyginimas. 10. Tvirtinimo medžiagos paruošimas ir paklojimas. Drenažinio kilimo pritvirtinimas metaliniais smeigais. 12. Šlaito užpylimas dirvožemiu. 13. Trašų išbėrimas. 14. Daugiamečių žolių užsėjimas. 15. Stulpelio PMS-200 pastatymas. 16. Plastikinių apsauginių grotelių įrengimas. 17. Išardytų sulūžusių drenažo žiočių išvežimas.

DARBO SANAUDOS IR MATERIALINIAI RESURSAI

Kodas	Darbų, mechanizmų, medžiagų ir gaminių pavadinimas	Resurso kiekis, mato vnt.
MN7P-0205	Drenažo žiočių keitimas 160, kai drenažo žiočių skersmuo 160 mm	1 vnt.
	Darbo sąnaudos: Vid. kategorijos 3,25 darbo sąnaudos	10,34 žm. val.
320034 340013	Mechanizmai: Vienkaušiai ekskavatoriai su iki 0,4 m ³ talpos kaušais Buldozeriai iki 59 kW (80 AJ) galingumo	1,60 maš. val. 0,84 maš. val.
900010 900082 120002 900069 900099 900072 900013	Medžiagos: Drenažo žiotys PE 160 mm skersmens Drenažo kilimas "Secudran R201 ES-601" Viela plieninė paprasta Dirvožemis Daugiamečių žolių sėklos Ritininė filtracinė medžiaga Melioracinis PE stulpelis PMS-200	1 vnt. 1,20 m ² 0,92 kg 0,17 m ³ 0,02 kg 0,35 m ² 1 vnt.

GP - 26 - TDP - 01 - B.3

Laida	Lapas	Lapų
0	2	3

200 mm skersmens polietileninės drenažo žiotys

PLANAS, PJŪVIAI, MAZGAS

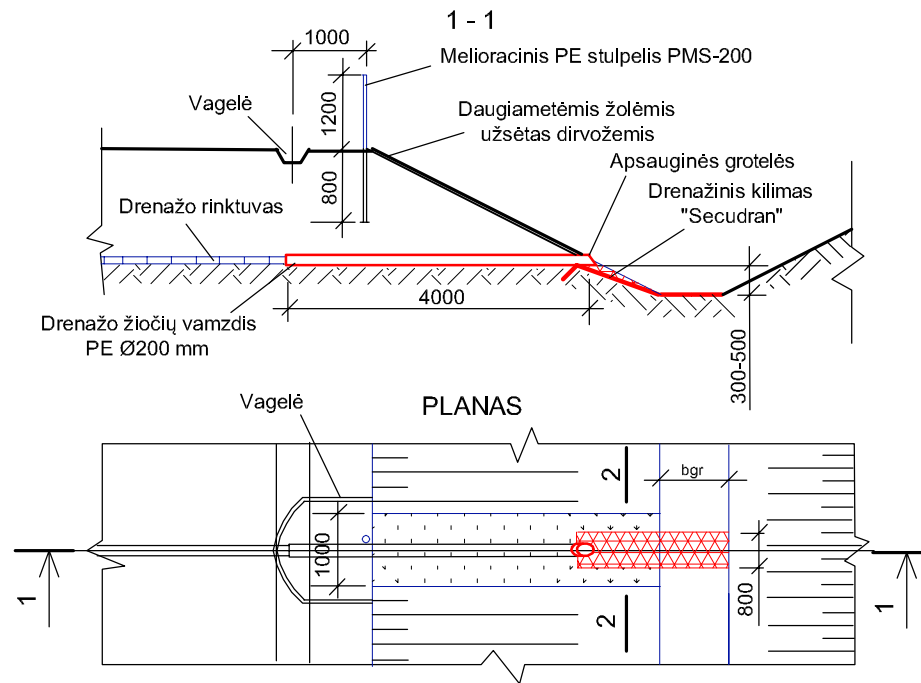

IŠTEKĖJIMO IŠ ŽIOČIŲ VAMZDŽIO MAZGAS

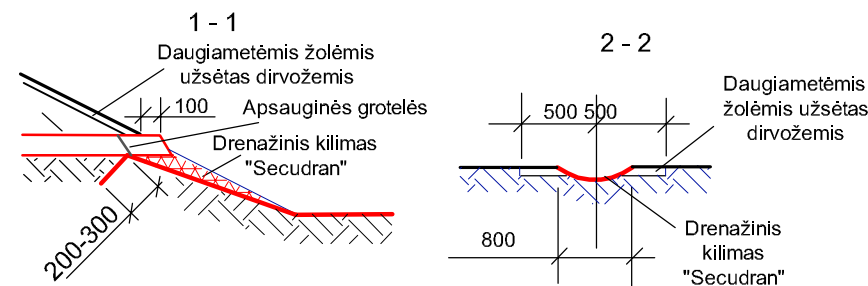

PASTABOS: 1. Drenažinis kilimas "Secudran" tvirtinamas prikalandant vielos Ø 5 mm, L 500 mm smaigais;
2. Rinktuvo vamzdžių ir žiočių sandūra sandarinama ritinine filtracine medžiaga.

DARBŲ SUDĖTIS, DARBO SANAUDOS IR MATERIALINIAI RESURSAI KEIČIANT ESAMAS ŽIOTIS

DARBŲ SUDĖTIS

1. Žiočių atkasimas ir išėmimas rankiniu būdu. 2. Rinktuvų atkasimas vienkaušiais ekskavatoriais. 3. Keraminių vamzdžių išėmimas. 4. Tranšėjų dugno paruošimas rankiniu būdu. 5. Polietileningų žiočių paklojimas. 6. Sujungimų užsandarinimas. 7. Drenažo žiočių pirminis užpylimas, sutankinant gruntą. 8. Tranšėjų užpylimas buldozeriu. 9. Šlaitų išlyginimas. 10. Tvirtinimo medžiagos paruošimas ir paklojimas. Drenažinio kilimo pritvirtinimas metaliniais smeigais. 12. Šlaito užpylimas dirvožemiu. 13. Trašų išbėrimas. 14. Daugiamečių žolių užsėjimas. 15. Stulpelio PMS-200 pastatymas. 16. Plastikinių apsauginių grotelių įrengimas. 17. Išardytų sulūžusių drenažo žiočių išvežimas.

DARBO SANAUDOS IR MATERIALINIAI RESURSAI

Kodas	Darbų, mechanizmų, medžiagų ir gaminių pavadinimas	Resurso kiekis, mato vnt.
MN7P-0205	Drenažo žiočių keitimas 200, kai drenažo žiočių skersmuo 200 mm	1 vnt.
	Darbo sąnaudos: Vid. kategorijos 3,24 darbo sąnaudos	10,58 žm. val.
320034 340013	Mechanizmai: Vienkaušiai ekskavatoriai su iki 0,4 m³ talpos kaušais Buldozeriai iki 59 kW (80 AJ) galingumo	1,60 maš. val. 0,84 maš. val.
	Medžiagos:	
900010	Drenažo žiotys PE 200 mm skersmens	1 vnt.
900082	Drenažo kilimas "Secudran R201 ES-601"	1,60 m²
120002	Vielos plieninė paprasta	1,16 kg
900069	Dirvožemis	0,17 m³
900099	Daugiamečių žolių sėklos	0,02 kg
900072	Ritininė filtracinė medžiaga	0,40 m²
900013	Melioracinis PE stulpelis PMS-200	1 vnt.

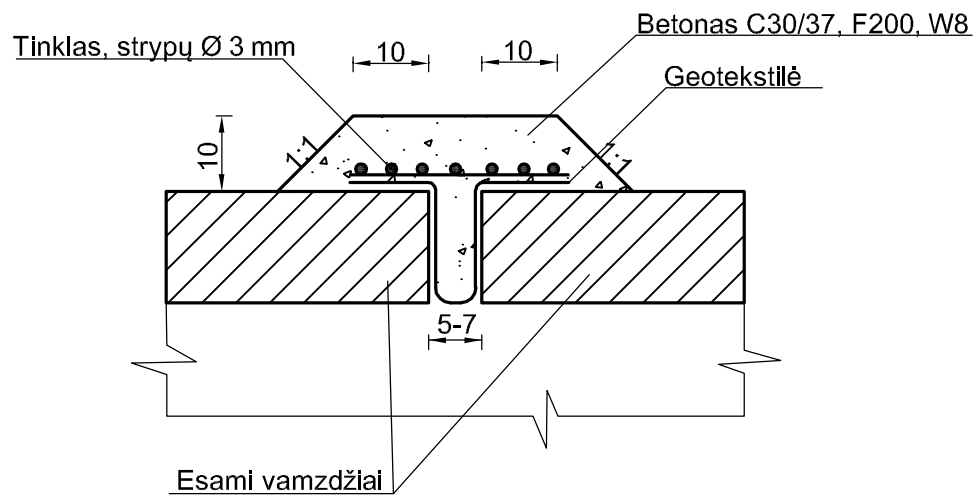

MEDŽIAGŲ SANTRAUKA VIENAI SIŪLEI

Pralaidos diametras (mm)	Neaustinė geotekstilė (m ²)	Vielos tinklėlis "akutės" 30x30 (m ² /kg)	Hidrotechninis betonas C30/37 (m ³)
750 - 800	1,73	1,10/4,11	0,13
1000	2,07	1,32/4,94	0,15
1200-1500	2,50	1,59/5,95	0,19
1500	3,03	1,93/7,22	0,22
1600	3,28	2,09/7,82	0,24

0	2026			
Laida	Išleidimo data	Laidos statusas. Keitimo priežastis (jei taikoma)		
Kval. patv. dok. Nr.			Lazdijų rajono savivaldybės Avižienių, Krosnos, Šeštokų ir Teizų kadastrinių vietovių dalių melioracijos statinių rekonstrukcija	
S-757-Pm	SPV	A. Gegužis	Tarpų tarp pralaidos vamzdžių užtaisymo schema	Laida
				0
LT	Lazdijų rajono savivaldybė		GP - 26 - TDP - 01 - B.4	Lapas
				Lapų
				1
				1

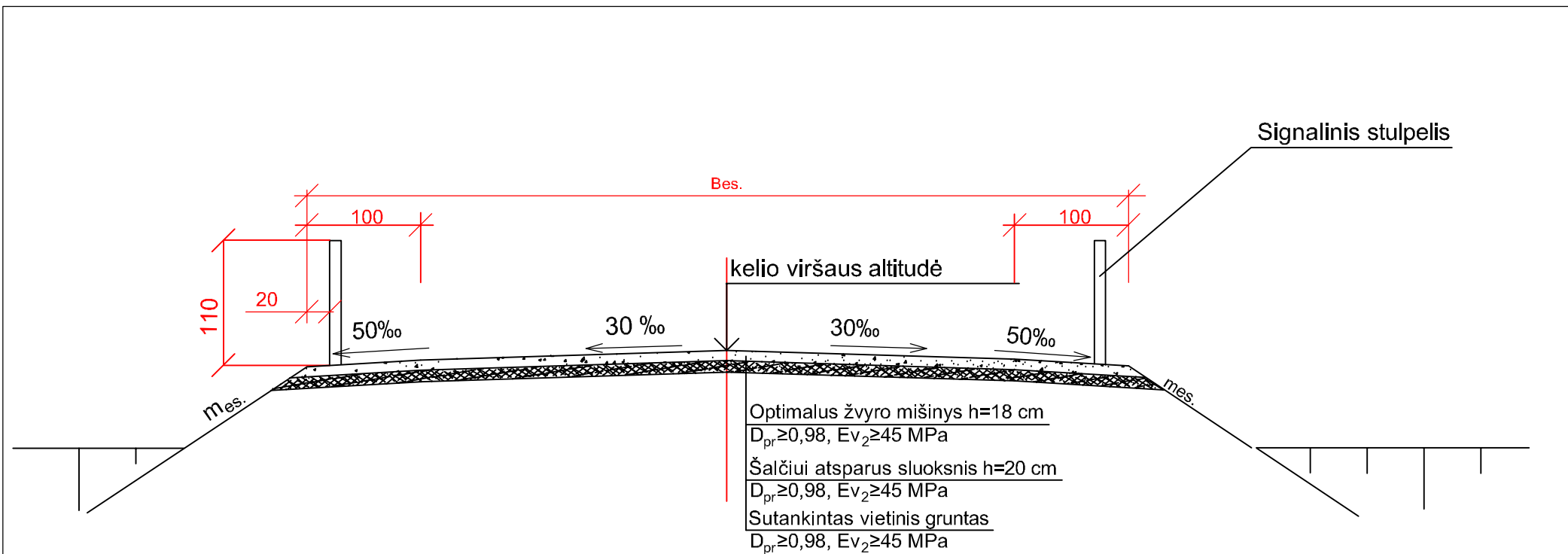

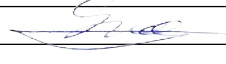
0	2026				
Laida	Išleidimo data	Laidos statusas. Keitimo priežastis (jei taikoma)			
Kval. patv. dok. Nr.				Lazdijų rajono savivaldybės Avižienių, Krosnos, Šeštokų ir Teizų kadastrinių vietovių dalių melioracijos statinių rekonstrukcija	
S-757-Pm	SPV	A. Gegužis			Laida
			Pravažiavimo virš pralaidų įrengimo konstrukcinis pjūvis		0
LT	Lazdijų rajono savivaldybė			GP - 26 - TDP - 01 - B.5	Lapas
					Lapų
					1
					1

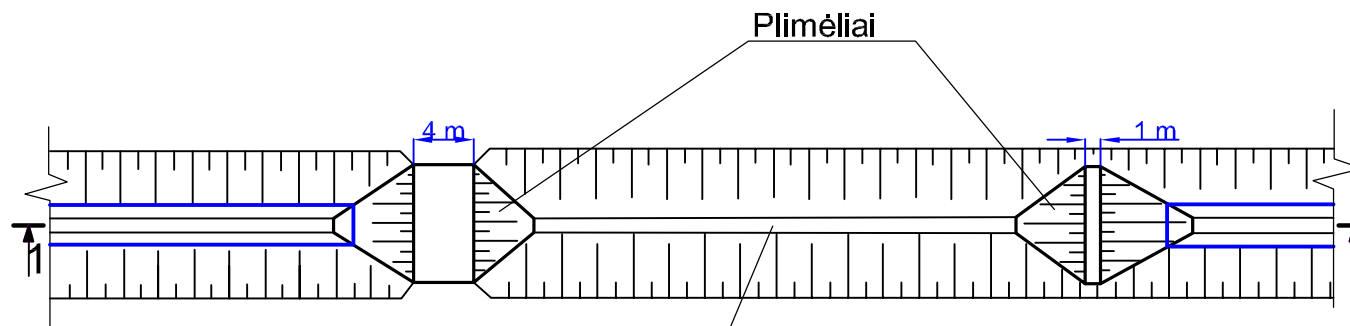

Rekonstruojamos pralaidos vieta

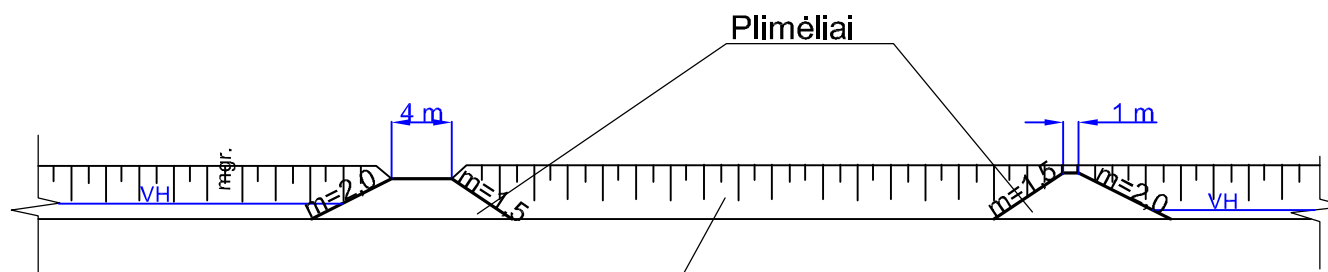

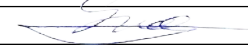

Rekonstruojamos pralaidos vieta

0	2026				
Laida	Išleidimo data	Laidos statusas. Keitimo priežastis (jei taikoma)			
Kval. patv. dok. Nr.				Lazdijų rajono savivaldybės Avižienių, Krosnos, Šeštokų ir Teizų kadastrinių vietovių dalių melioracijos statinių rekonstrukcija	
S-757-Pm	SPV	A. Gegužis			Laida
			Laikinių pylimėlių įrengimo schema		0
LT	Lazdijų rajono savivaldybė			GP - 26 - TDP - 01 - B.6	Lapas
					Lapų
				1	1

BVS schema

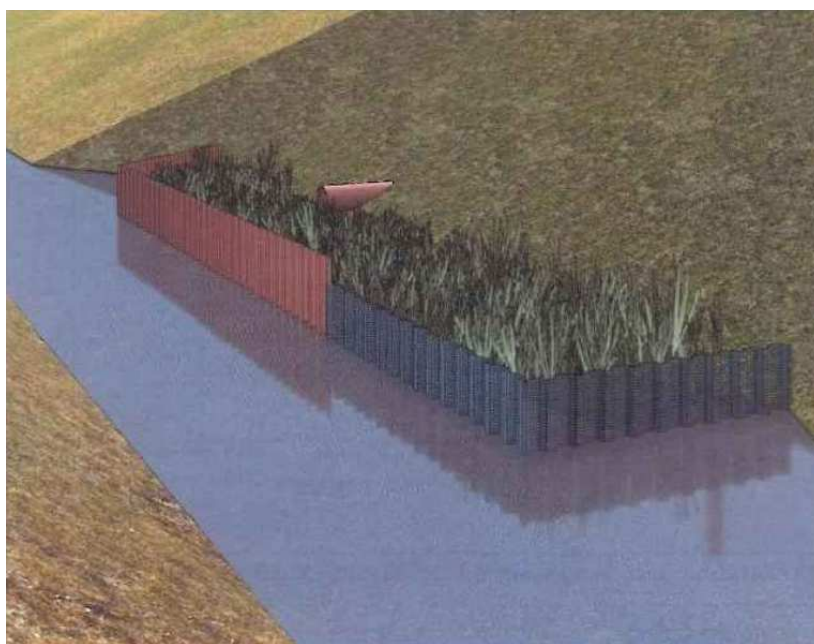
Drenažo vandens biologinio valymo sistema su pelkine augmenija

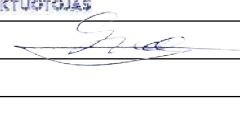

0	2026				
Laida	Išleidimo data	Laidos statusas. Keitimo priežastis (jei taikoma)			
Kval. patv. dok. Nr.				Lazdijų rajono savivaldybės Avižienių, Krosnos, Šeštokų ir Teizų kadastrinių vietovių dalių melioracijos statinių rekonstrukcija	
S-757-Pm	SPV	A. Gegužis		Drenažo vandens biologinio valymo sistemos (BVS) su pelkine augmenija, įrengimo principinė schema	Laida
					0
LT	Lazdijų rajono savivaldybė			GP - 26 - TDP - 01 - B.7	Lapas
					Lapų
					1
					3

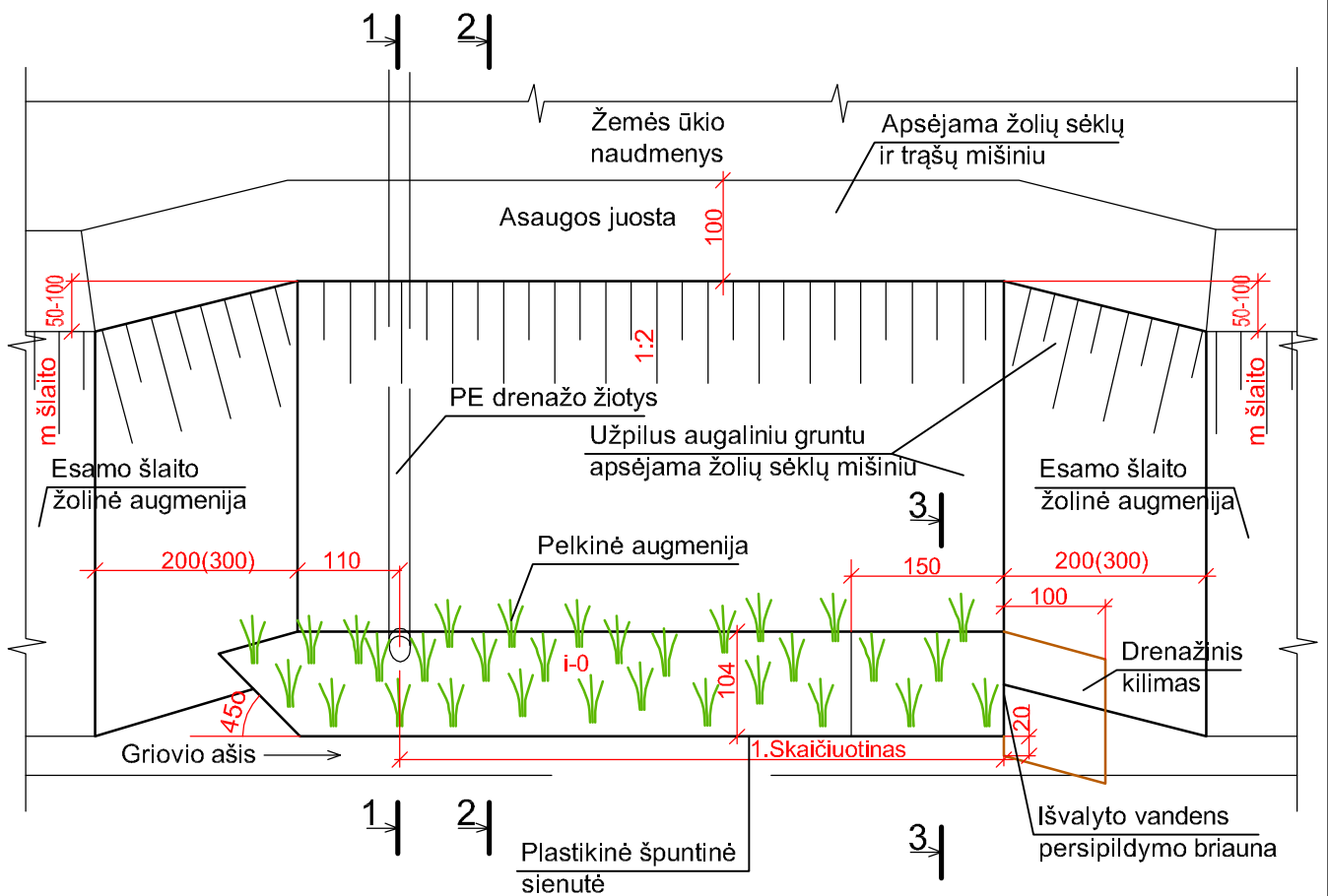
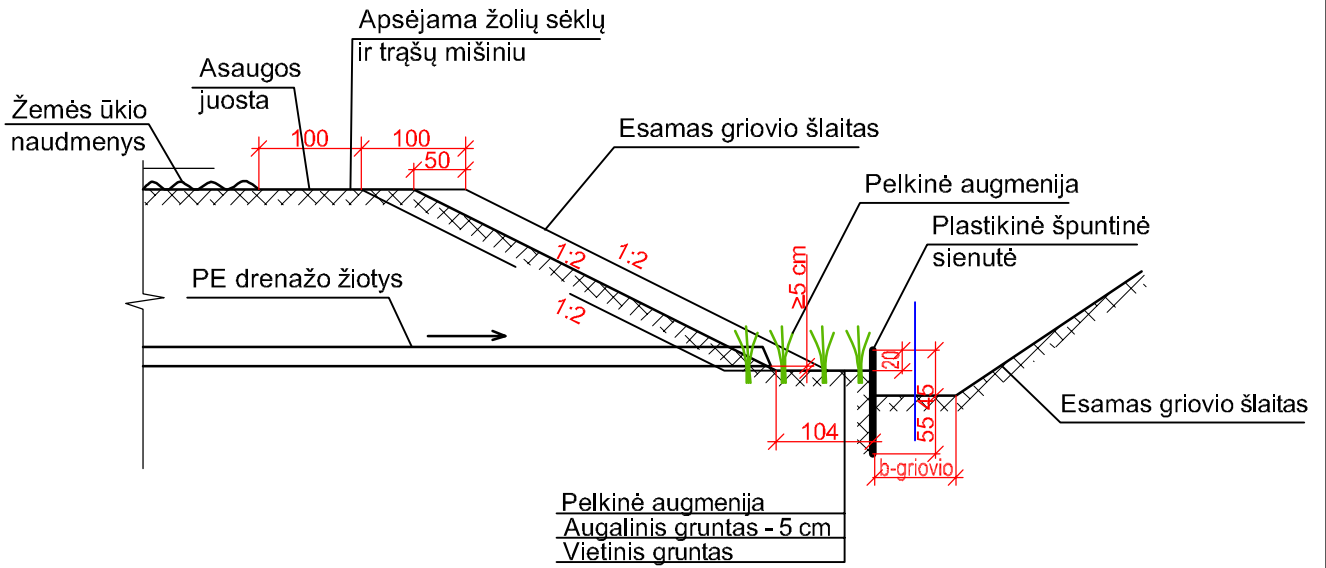

Pastaba: matmenys brėžinyje duoti cm.

2-2

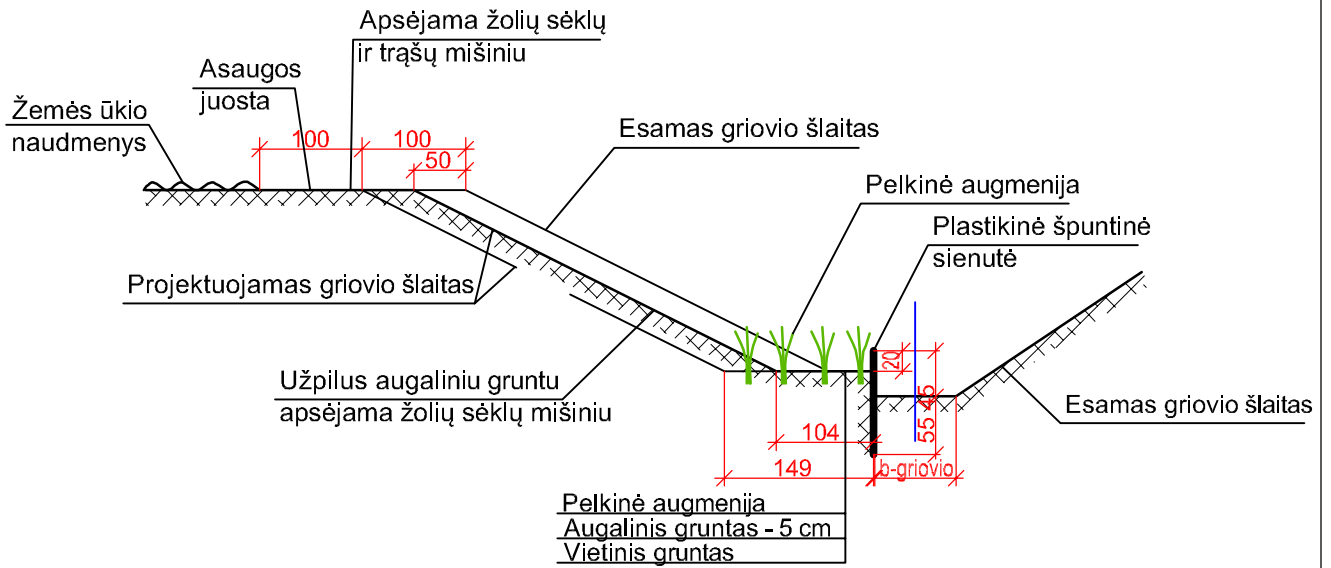

BVS sistema M1:50

3-3

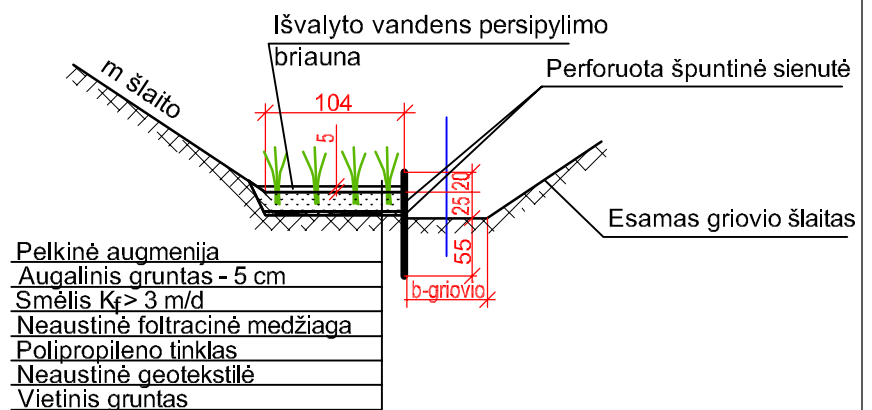



Pastaba: matmenys brėžinyje duoti cm.

Kai L skaičiuotinas - 10 metrų, griovio gylis 2 m, gr. šlaito koef. m 1:2

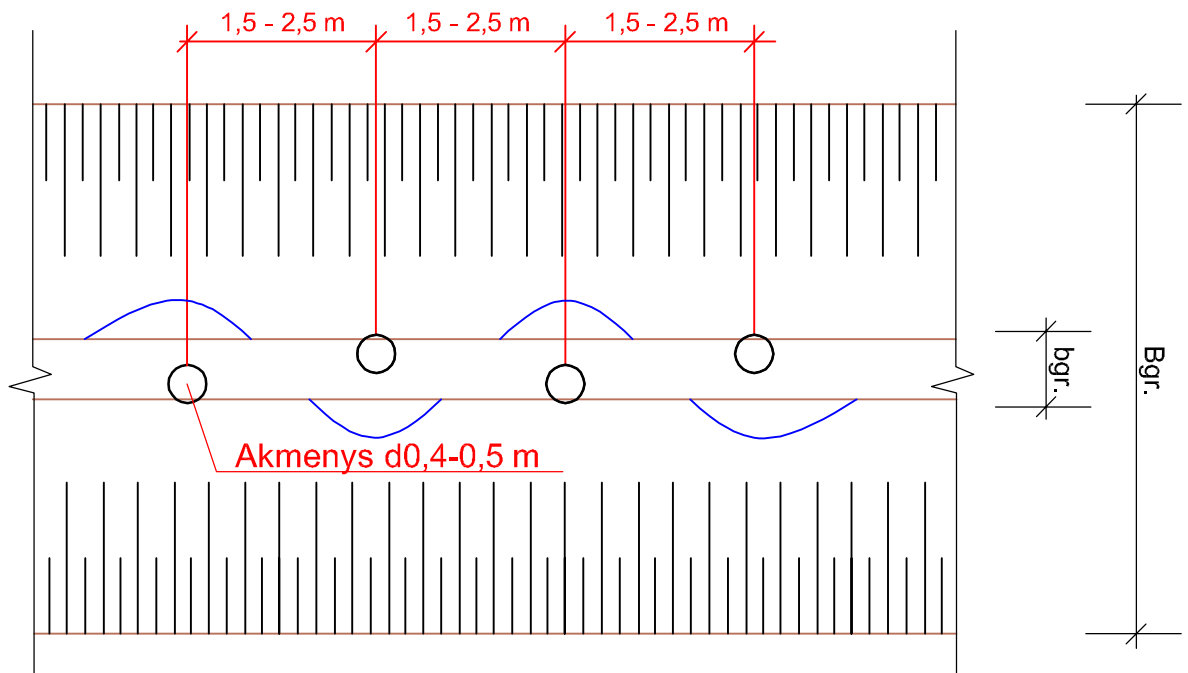
Medžiagos gaminiai, pavadinimai	Resurso kiekis
Smėlis	12 m ²
Špuntinė sienutė	13 m
Žolių sėklų mišinys šlaitų tvirtinimui	0,270 kg
Augalinis gruntas šlaitų tvirtinimui	2 m ³
Mineralinių trąšų mišinys šlaitų tvirtinimui	1,600 kg
Neaustinė filtracinė medžiaga	3 m ²
Geotekstilė	3 m ²
Polipropileno tinklas	3 m ²
Pelkiniai augalai (daigai 4 vnt./m ²)	48 vnt.
Drenažinis kilimas	1,3 m ²
Augalinis gruntas pelkinei augmenijai	0,6 m ³
Žolių sėklų mišinys apsaugos juostai	0,064 kg
Mineralinių trąšų mišinys apsaugos juostai	0,384 kg



0	2026				
Laida	Išleidimo data	Laidos statusas. Keitimo priežastis (jei taikoma)			
Kval. patv. dok. Nr.				Lazdijų rajono savivaldybės Avižienių, Krosnos, Šeštokų ir Teizų kadastrinių vietovių dalių melioracijos statinių rekonstrukcija	
S-757-Pm	SPV	A. Gegužis		Pavienių akmenų įrengimo schema	
				Laida	0
LT	Lazdijų rajono savivaldybė			GP - 26 - TDP - 01 - B.8	
				Lapas	Lapų
				1	1

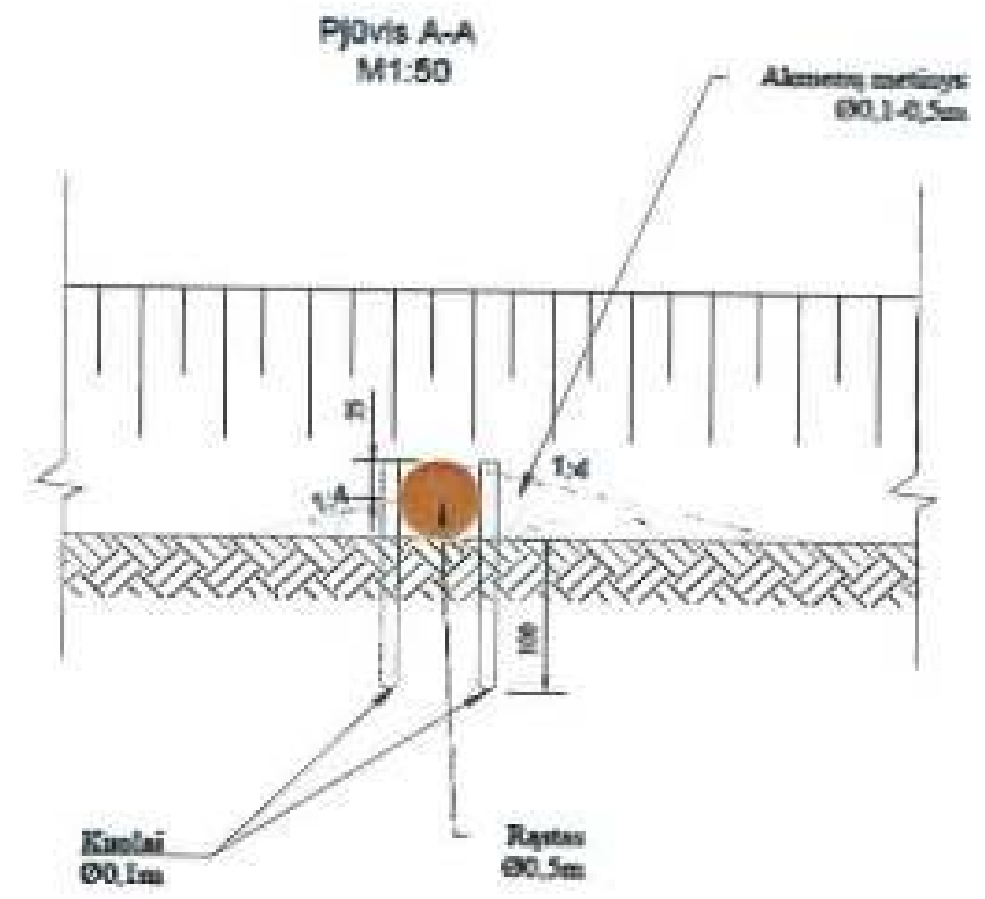
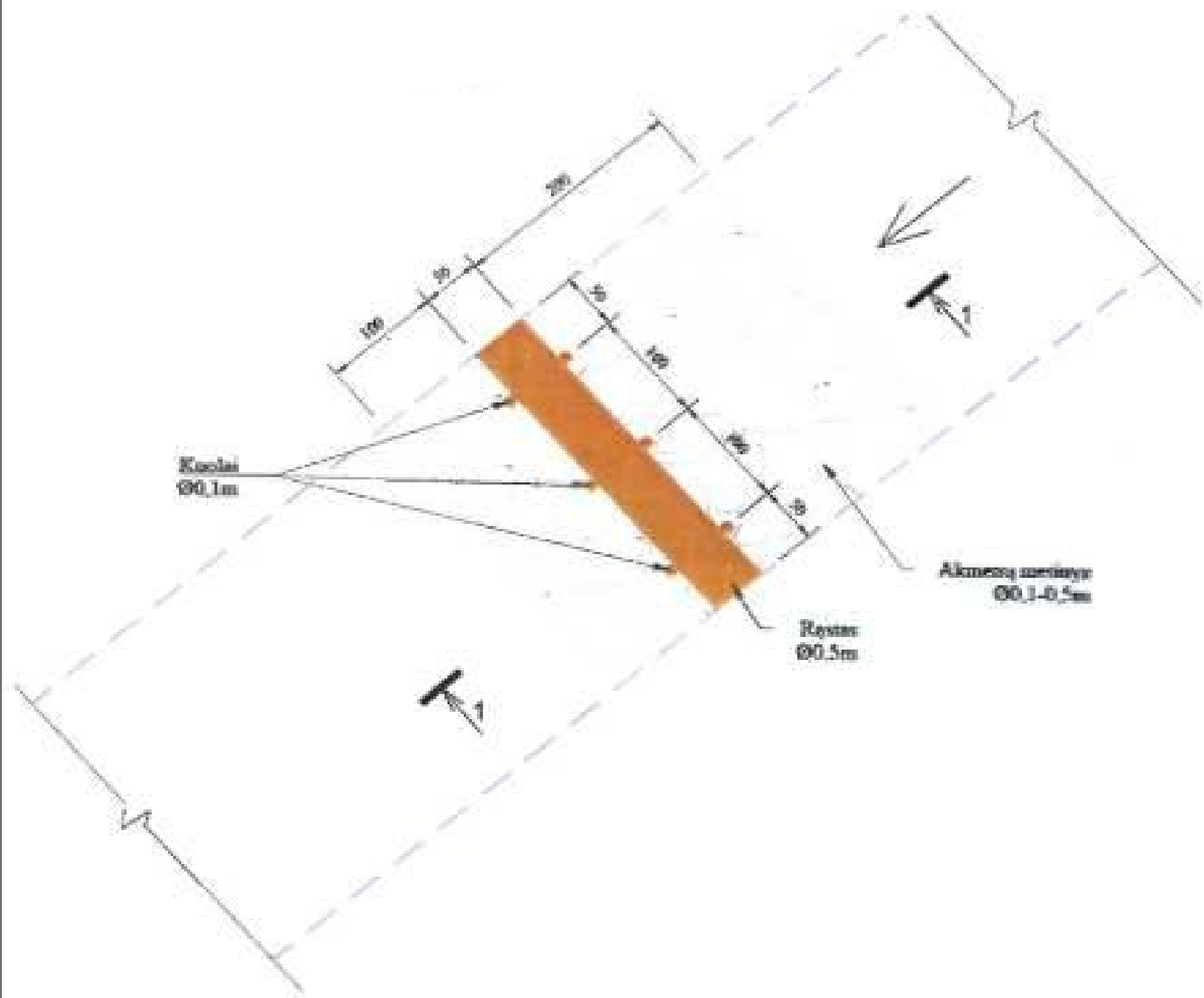

Pastaba:
 1. Kaulai talami į ne mažesnę nei 1m gylį.
 2. Matavimai brėžinyje duoti centimetrais.

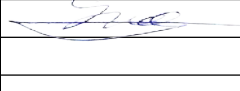
0	2026			
Laida	Išleidimo data	Laidos statusas. Keitimo priežastis (jei taikoma)		
Kval. patv. dok. Nr.			Lazdijų rajono savivaldybės Avižienių, Krosnos, Šeštokų ir Teizų kadastrinių vietovių dalių melioracijos statinių reconstructija	
S-757-Pm	SPV	A. Gegužis		Laida
				0
LT	Lazdijų rajono savivaldybė		GP - 26 - TDP - 01 - B.9	Lapas
				Lapa
				1
				1

MONOLITINIS ANTGALIS
60 ir 80 cm SKERSMENS PRALAIMOMS

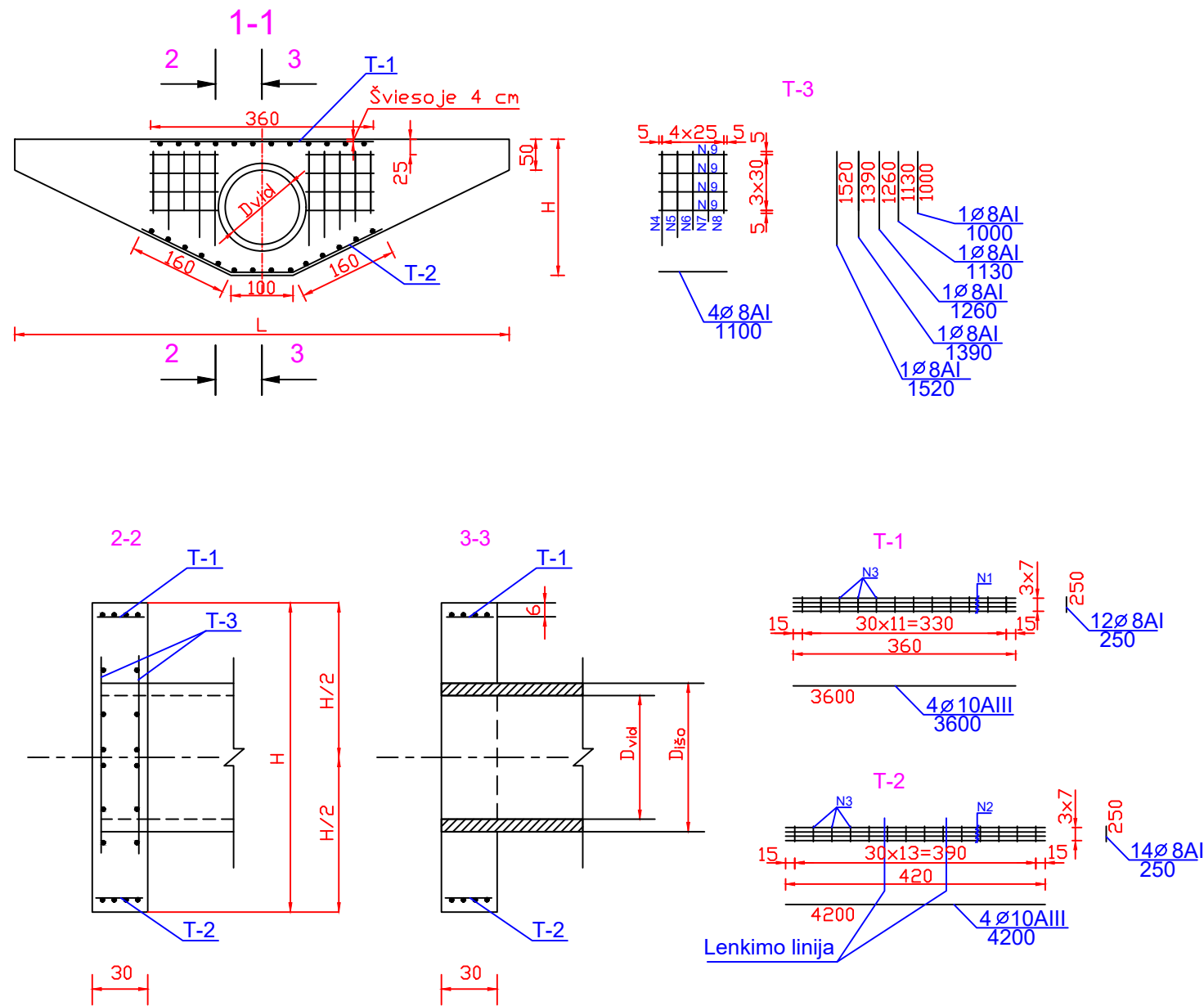

ARMATŪROS SPECIFIKACIJA

Karkaso Nr. ir kiekis	Strypo			1 m ¹ svoris kg	Bendras		
	Nr.	Ø, klasė mm	Ilgis mm		Kiekis vnt	Ilgis m	Svoris kg
T-1 1-vnt	1	10AIII	3000	0,617	4	12,00	7,40
	3	8AI	250	0,395	10	2,50	0,99
T-2 1-vnt	2	10AIII	3500	0,617	4	14,00	8,64
	3	8AI	250	0,395	12	3,00	1,18
T-3 4-vnt	4	8AI	1390	0,395	4	5,56	2,20
	5	8AI	1260	0,395	4	5,04	1,18
	6	8AI	1130	0,395	4	4,52	1,78
	7	8AI	1000	0,395	4	4,00	1,58
Viso:					AI	15,09	
					AIII	16,04	

TECHNINIAI EKONOMINIAI RODIKLIAI

Pralaidos diametras, cm	Strypo			Betonas		Armatūra, kg	
	L	H	D _{vid}	Charakteristika	Kiekis m ³	Ø, klasė	
Ø 60	500	160	60	C30/37	1,62	8AI	15,09
Ø 80	600	180	80	C30/37	2,05	10AIII	16,04

0	2026		
Laida	Išleidimo data	Laidos statusas. Keitimo priežastis (jei taikoma)	
Kval. patv. dok. Nr.			Lazdijų rajono savivaldybės Avizienuų, Krosnos, Šeštokuų ir Teizų kadastrinių vietovių dalių melioracijos statinių rekonstrukcija
S-757-Pm	SPV	A. Gegužis	Laida
			Monolitinių antgalių pralaidoms įrengimo schemos
			0
LT	Lazdijų rajono savivaldybė		GP - 26 - TDP - 01 - B.10
			Lapas
			Lapų
			1
			3

MONOLITINIS ANTGALIS
100 cm SKERSMENS PRALAIDOMS

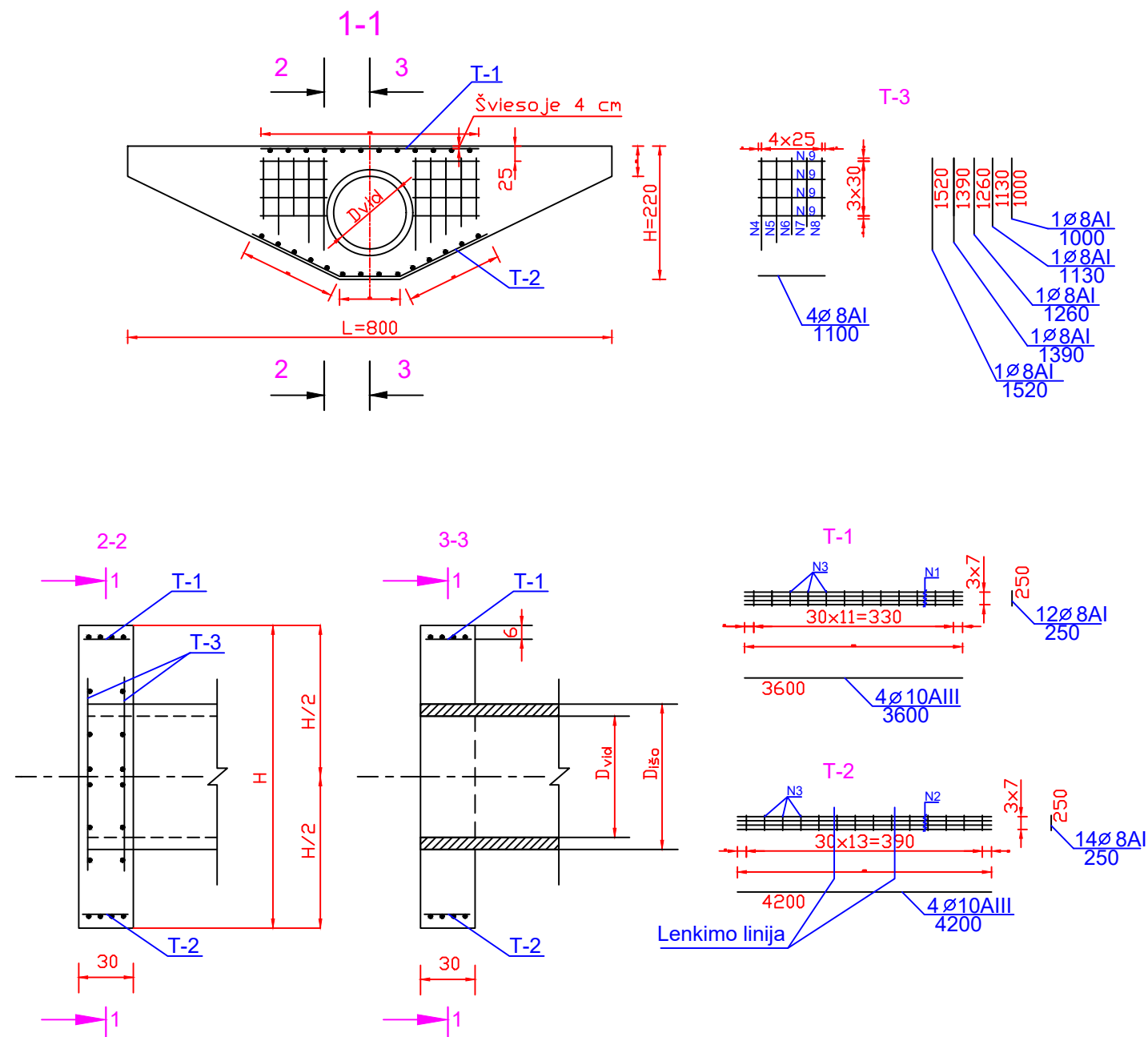

ARMATŪROS SPECIFIKACIJA

Karkaso Nr. ir kiekis	Strypo			1 m ¹ svoris kg	Bendras		
	Nr.	Ø, klasė mm	Ilgis mm		Kiekis vnt	Ilgis m	Svoris kg
T-1 1-vnt	1	10AIII	3600	0,617	4	14,40	8,88
	3	8AI	250	0,395	12	3,00	1,18
T-2 1-vnt	2	10AIII	4200	0,617	4	16,80	10,36
	3	8AI	250	0,395	14	3,50	1,38
T-3 1-vnt	4	8AI	1520	0,395	4	6,08	2,40
	5	8AI	1390	0,395	4	5,56	2,20
	6	8AI	1260	0,395	4	5,04	1,99
	7	8AI	1130	0,395	4	4,52	1,78
	8	8AI	1000	0,395	4	4,00	1,58
	9	8AI	1100	0,395	16	17,60	6,95
Viso:					AI	19,46	
					AIII	19,24	

TECHNINIAI EKONOMINIAI RODIKLIAI

Pralaidos diametras, cm	Strypo			Charakteristika	Betonas Kiekis m ³	Armatūra, kg	
	L	H	D _{vid}			Ø, klasė	8AI
Ø 100	700	200	100	C30/37	2,51	19,46	19,24
Ø 120	800	220	120	C30/37	3,03	19,46	19,24

**MONOLITINIS ANTGALIS
160 cm SKERSMENS PRALAIDAI**

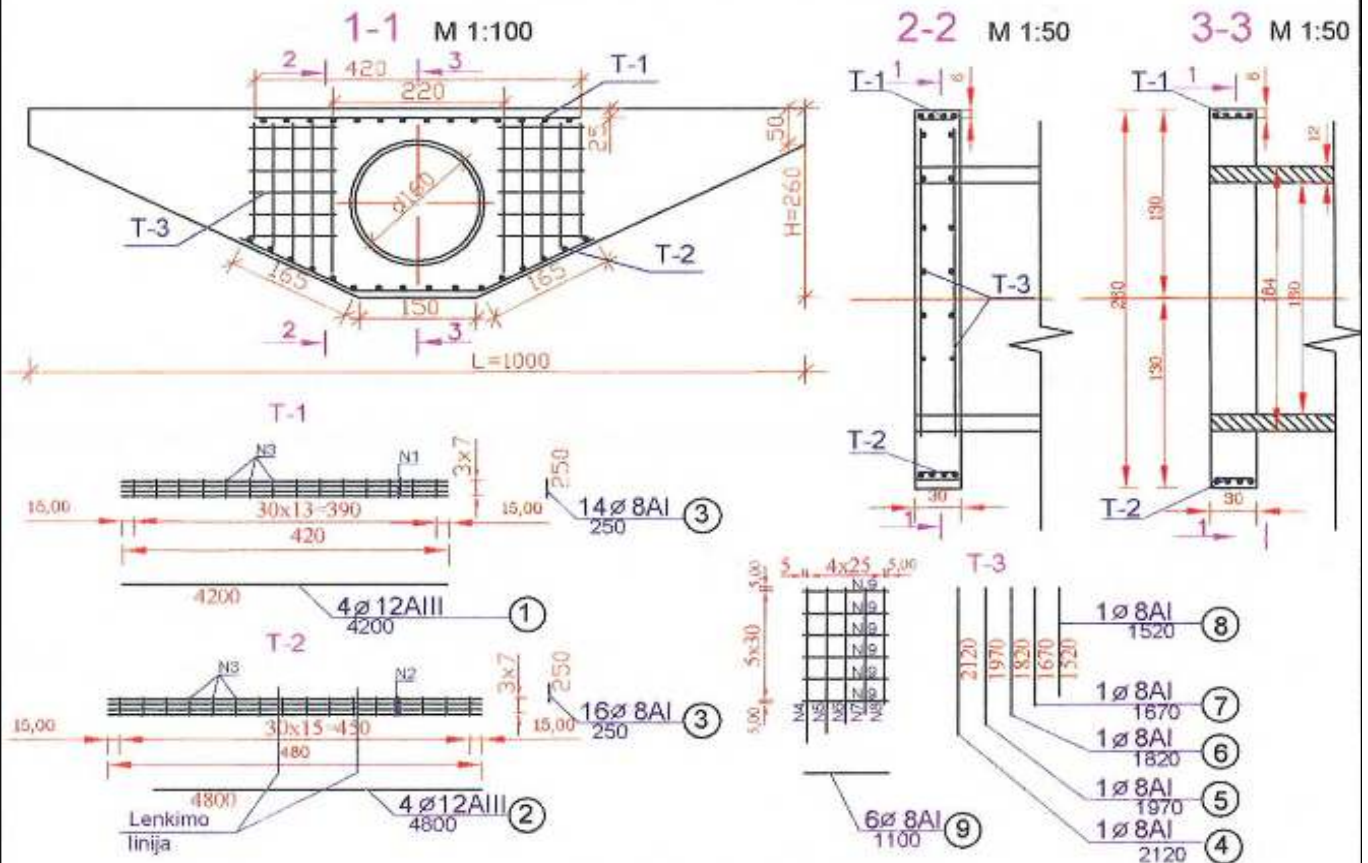

ARMATŪROS SPECIFIKACIJA

Karkaso Nr. ir kiekis	Strypo			1 m ³ svoris kg	Bendras		
	Nr.	Ø, klasė mm	Ilgis mm		Kiekis vnt	Ilgis m	Svoris kg
T-1 1-vnt	1	12AIII	4200	0,888	4	16,80	14,92
	3	8AI	250	0,395	14	3,50	1,38
T-2 1-vnt	2	12AIII	4800	0,888	4	19,20	17,05
	3	8AI	250	0,395	16	4,00	1,58
T-3 1-vnt	4	8AI	2120	0,395	4	8,48	3,35
	5	8AI	1970	0,395	4	7,88	3,11
	6	8AI	1820	0,395	4	7,28	2,88
	7	8AI	1670	0,395	4	6,68	2,64
	8	8AI	1520	0,395	4	6,08	2,40
	9	8AI	1100	0,395	24	26,40	10,48
Viso:					AI		27,77
					AIII		31,97

ANTGALIO TECHINIAI EKONOMINIAI RODIKLIAI

Pralaidos diametras, cm	Antgalio matmenys cm			Betonas		Armatūra, kg	
	L	H	D	Charakteristika	Kiekis m ³	Ø, klasė	
						8AI	10AIII
Ø 160	1000	260	160	C30/37	4,36	27,77	31,97

PASTABA: 1. Matmenys brėzinyje nurodyti centimetrais, armatūra mm.

Gofruotų vamzdžių d0,6 m pralaidos įrengimo schemas

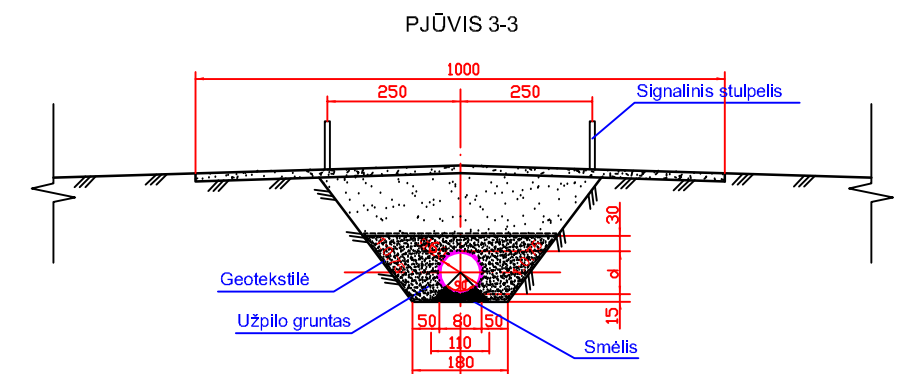
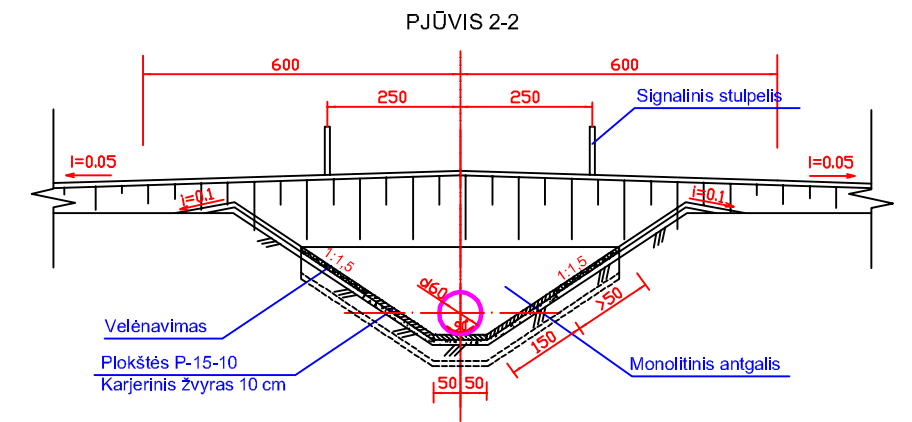
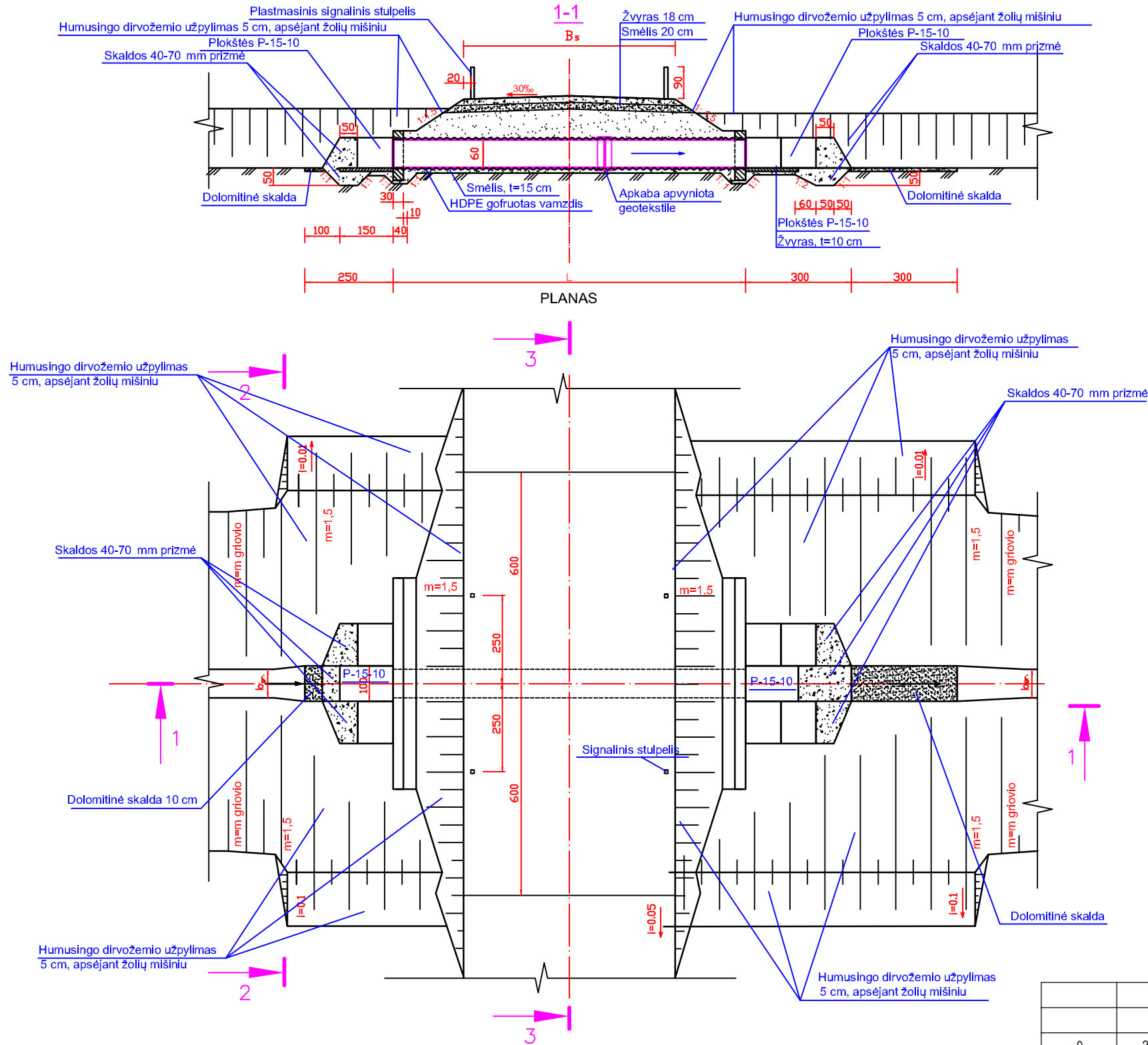

Rengiant pralaidas vadovautis "Vandens pralaidų konstrukcinių sprendimų taikymo melioracijos statinių statyboje taisyklėmis"

Užpildui naudojamas vietinis priemolio gruntas, kurio sudėtyje neturi būti stambesnių dalelių už pralaidos bangos tipą. Užpildas pilamas 15 cm storio sluoksniais, simetriškai iš abiejų pralaidos pusių, sutankinant kiekvieną sluoksnį ne mažiau 97 % (pagal Proktorą).

PASTABOS:

1. Gruntu užpildami betoninių konstrukcijų paviršiai dažomi du kartus karštu bitumu.
2. Užpylimo aukštis virš pralaidos turi būti ne mažiau 0.7 m ir ne daugiau 4 m.
3. Skaldos prizmę galima pakeisti akmenų užmetimu.
4. Matmenys brėžinyje nurodyti centimetrais.

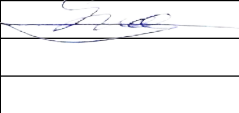
0	2026	Laidos statusas. Keitimo priežastis (jei taikoma)							
Kval. patv. dok. Nr.			Lazdijų rajono savivaldybės Avižienių, Krosnos, Šeštokų ir Teizų kadastrinių vietovių dalių melioracijos statinių rekonstrukcija						
S-757-Pm	SPV	A. Gegužis							
LT	Lazdijų rajono savivaldybė	GP - 26 - TDP - 01 - B.11	<table border="1"> <tr> <td>Laida</td> <td>0</td> </tr> <tr> <td>Lapas</td> <td>1</td> </tr> <tr> <td>Lapų</td> <td>3</td> </tr> </table>	Laida	0	Lapas	1	Lapų	3
Laida	0								
Lapas	1								
Lapų	3								

SUDERINTA _____

TVIRTINU _____

Žemės ūkio skyriausAdministracijos direktorė

ė

(pareigos, vardas, pavardė)

(pareigos, vardas, pavardė)

2025 m. gruodžio d.

2025 m. gruodžio d.

**PROJEKTO „LAZDIJŲ R. SAV. AVIŽIENIŲ, KROSNOS, ŠEŠTOKŲ IR TEIZŲ
KADASTRINIŲ VIETOVIŲ DALIŲ MELIORACIJOS STATINIŲ REKONSTRUKCIJA“
TECHNINIO DARBO PROJEKTO PARENGIMO**

TECHNINĖ UŽDUOTIS

2025-12- Nr. ŽŪ4-

1. BENDROJI INFORMACIJA

1.1. UŽSAKOVAS (STATYTOJAS)

Lazdijų rajono savivaldybės administracija (kodas 188714992), Vilniaus g. 1, 67106 Lazdijai.

2. OBJEKTAS

Projekto „Lazdijų r. sav. Avižienių, Krosnos, Šeštokų ir Teizų kadastrinių vietovių dalių melioracijos statinių rekonstrukcija“ techninio darbo projekto parengimas.

2.1. OBJEKTO ĮGYVENDINIMO VIETA

Statinių vieta: Lazdijų rajono Avižienių, Krosnos, Šeštokų ir Teizų kadastrinės vietovės. Statybos rūšis – rekonstravimas. Planuojama rekonstruoti funkciniais ryšiais susijusius melioracijos statinius.

2.2. BENDRIEJI TECHNINIAI RODIKLIAI

Rodiklių pavadinimas	Mato vnt.	Kiekis
Rekonstruojamų griovių ilgis	km	20,452
Rekonstruojamų griovių aptarnaujamas plotas	ha	406
Vandens pralaidų skaičius	vnt.	17
Rekonstruojamų drenažo žiočių skaičius	vnt.	185

Projekto rengimo tikslas - parengti pagal Lazdijų rajono savivaldybės Avižienių, Krosnos, Šeštokų ir Teizų kadastrinių vietovių dalių melioracijos statinių rekonstrukcijos tyrinėjimo darbų dokumentaciją (pridedamas) blogos būklės melioracijos sistemų rekonstrukcijos techninį - darbo

projektą.

Dažniausiai pasitaikantys gedimai yra: sąnašos (uždumblėjimas), išsiklaipę vamzdžiai, ant melioracijos statinių užaugę medžiai, krūmai, griovių uždumblėjimas, įsiurbimai, tarpai tarp žiedų pralaidose, jų užnešimas sąnašomis, pralaidų deformacijos.

3. PROJEKTAVIMO PASLAUGOS

3.1. Techninio darbo projekto parengimo ir su jo parengimu susijusios paslaugos:

3.1.1. Techninis darbo projektas turės būti parengtas atskirai kiekvienai kadastro vietai;

3.1.2. jei reikalinga atlikti planuojamos ūkinės veiklos atranką dėl poveikio aplinkai vertinimo ir planuojamos ūkinės veiklos poveikio aplinkai vertinimą, kaip tai numatyta Lietuvos Respublikos planuojamos ūkinės veiklos poveikio aplinkai vertinimo įstatyme;

3.1.3. parengti projektinius pasiūlymus ir juos suderinti su Lazdijų rajono savivaldybės administracijos atsakingu specialistu;

3.1.4. techninis darbo projektas turi būti suderintas su visais asmenimis, kurių inžineriniai tinklai, statiniai, kiti susiję interesai, turi sąveikos su projektuojamu objektu bei Statytoju (Užsakovu);

3.1.5. rengiant techninį darbo projektą nepažeisti trečiųjų šalių ir asmenų interesų.

3.1.6. techninio darbo projekto ekspertizė privaloma. Ekspertizės paslaugą atliks Lietuvos Respublikos viešųjų pirkimų įstatymo nustatyta tvarka Užsakovo parinktas Ekspertas. Projekto rengėjas privalės pakoreguoti Projektą pagal ekspertų bei kitų atsakingų asmenų/institucijų pastabas.

3.1.7. techninio darbo projekto rengėjas atsakingas už parengto Projekto įkėlimą į IS Infostatybą ir statybą leidžiančio dokumento išėmimą (jei statybą leidžiantis dokumentas privalomas).

3.1.8. Paslaugas atlikti: per 4 mėnesius nuo sutarties pasirašymo.

3.1.9. Paslaugų tiekėjas pats apsirūpina reikalingomis priemonėmis, įranga, medžiagomis ir žmogiškaisiais ištekliais.

3.1.10. Paslaugų teikėjas po sutarties pasirašymo per 5 (penkias) darbo dienas privalo pateikti ir su užsakovu suderinti darbų atlikimo grafiką.

3.2. Nurodymai techninio darbo projekto rengimui:

3.2.1. Techninis darbo projektas rengiamas vadovaujantis Lietuvos Respublikos statybos įstatymu, Lietuvos Respublikos melioracijos įstatymu, melioracijos techniniais reglamentais MTR 1.05.01:2005 „Melioracijos statinių projektavimas“, ir kitais melioracijos normatyviniais dokumentais, standartais, normomis, statybos techniniais reglamentais bei projektavimo užduotimi bei kitais reglamentuojančiais dokumentais ir teisės aktais;

3.2.2. Pagrindinės projekto sudedamosios dalys:

3.2.2.1. Bendroji dalis:

- bendrieji duomenys – melioracijos statinių projekto pavadinimas, kuriame turi būti tiksliai nurodyta vietovė, statinių pavadinimas, vietovės schema;

- melioracijos statinių projektavimo užduotis ir kiti privalomieji projekto rengimo dokumentai;

- bendrieji techniniai rodikliai;

- aiškinamasis raštas (raštu pateikta trumpa tyrinėjimų medžiagos apžvalga ir išvados, priimtų projektinių sprendinių paaiškinimas, aptarti pagrindiniai skaičiavimų rezultatai, ypatingi statybos atvejai, principinių sprendinių trumpas aprašymas, apsauginės zonos ir kt.)

- techninės specifikacijos (techniniai reikalavimai). Projektiniams sprendiniams įgyvendinti reikalingos sąlygos, statybos produktų, įrenginių ir statybos darbų techniniai reikalavimai melioracijos statinių statybos skaičiuojamajai kainai nustatyti, statybos darbų kokybės kontrolei vykdyti ir pastatytiems melioracijos statiniams naudoti;

- statybos produktų, įrenginių ir darbų kiekių žiniaraščiai, išskiriant melioracijos statinių grupes;

- inžineriniai skaičiavimai melioracijos statinių parametrų patikslinti;

- projektiniai sprendiniai pavaizduoti planuose ir brėžiniuose (planai, griovių, drenažo, tiltų išilginiai ir skersiniai, profiliai ir kt.);
- informuoti visuomenę apie rengiamą melioracijos projektą vietinėje spaudoje;
- reperių katalogas;
- brėžiniai melioracijos statinių statybos bei montavimo darbams vykdyti.

3.2.2.2. Statybos skaičiuojamos kainos nustatymas. Melioracijos statinių statybos kainos skaičiavimais įvertinama statybos produktų, statybos montavimo darbų ir mechanizmų sąnaudų kaina, visos papildomos išlaidos, susijusios su statyba. Išplėstinės lokalinės sąmatos parengiamos pagal darbų kiekių žiniaraštį, išskiriant melioracijos statinių grupes.

3.2.3. Statytojui (Užsakovui) pateikiami 4 (keturi) techninio darbo projekto popieriniai egzemplioriai ir 2 (du) egzemplioriai techninio darbo projekto (pilnos apimties) įrašyto į kompiuterinę laikmeną (*.pdf formatu); papildomai pateikiami brėžiniai (*.dwg formatu).

3.2.4. Paslaugų teikėjas gavęs atlygį už parengtą projektą, raštiškai atsisako visų autorinių teisių į šį projektą.

4. PRIEDAI

4.1. Projekto Lazdijų rajono savivaldybės Avižienių, Krosnos, Šeštokų ir Teizų kadastrinių vietovių magistralinių melioracijos griovių ir juose esančių melioracijos statinių rekonstravimas tyrinėjimo darbų dokumentacija, 35 lapai.

Žemės ūkio skyriaus vyr. specialistas

DETALŪS METADUOMENYS

Dokumento sudarytojas (-ai)	Lazdijų rajono savivaldybės administracija
Dokumento pavadinimas (antraštė)	PROJEKTO „LAZDIJŲ R. SAV. AVIŽIENIŲ, KROSNOS, ŠEŠTOKŲ IR TEIZŲ KADASTRINIŲ VIETОВIŲ DALIŲ MELIORACIJOS STATINIŲ REKONSTRUKCIJA“ TECHNINIO DARBO PROJEKTO PARENGIMO TECHNINĖ UŽDUOTIS
Registracija #1	
Dokumento registracijos data ir numeris	2025-12-03T14:04:30.34+02:00, ŽŪ4-51
Dokumento specifikacijos identifikavimo žymuo	ADOC-V1.0
Parašas #1	
Parašo paskirtis	Suderinimas
Parašą sukūrusio asmens vardas, pavardė ir pareigos	, Vedėja
Parašo sukūrimo data ir laikas	2025-12-02T17:05:37.2256134+02:00
Parašo formatas	Kvalifikuotas elektroninis parašas
Laiko žymoje nurodytas laikas	2025-12-02T17:06:31+02:00
Informacija apie sertifikavimo paslaugų teikėją	EID-SK 2016 AS Sertifitseerimiskeskus EE
Sertifikato galiojimo laikas	2028-07-30T23:59:59+03:00
Parašas #2	
Parašo paskirtis	Pasirašymas
Parašą sukūrusio asmens vardas, pavardė ir pareigos	, Vedėja
Parašo sukūrimo data ir laikas	2025-12-02T17:06:32.3663382+02:00
Parašo formatas	Kvalifikuotas elektroninis parašas
Laiko žymoje nurodytas laikas	2025-12-02T17:07:26+02:00
Informacija apie sertifikavimo paslaugų teikėją	EID-SK 2016 AS Sertifitseerimiskeskus

	EE
Sertifikato galiojimo laikas	2028-07-30T23:59:59+03:00
Parašas #3	
Parašo paskirtis	Tvirtinimas
Parašą sukūrusio asmens vardas, pavardė ir pareigos	ė, Direktorė
Parašo sukūrimo data ir laikas	2025-12-03T13:54:34.7718188+02:00
Parašo formatas	Kvalifikuotas elektroninis parašas
Laiko žymoje nurodytas laikas	2025-12-03T13:55:39+02:00
Informacija apie sertifikavimo paslaugų teikėją	EID-SK 2016 AS Sertifitseerimiskeskus EE
Sertifikato galiojimo laikas	2028-06-21T23:59:59+03:00
Parašas #4	
Parašo paskirtis	Pasirašymas
Parašą sukūrusio asmens vardas, pavardė ir pareigos	r. specialistas
Parašo sukūrimo data ir laikas	2025-12-03T14:37:50.7164525+02:00
Parašo formatas	Kvalifikuotas elektroninis parašas
Laiko žymoje nurodytas laikas	2025-12-03T14:38:55+02:00
Informacija apie sertifikavimo paslaugų teikėją	SK ID Solutions EID-Q 2021E SK ID Solutions AS EE
Sertifikato galiojimo laikas	2030-02-24T23:59:59+02:00
Informacija apie būdus, naudotus metaduomenų vientisumui užtikrinti	Metaduomenų vientisumas užtikrintas elektroniniais parašais
Pagrindinio dokumento priedų skaičius	1
Pagrindinio dokumento pridedamų dokumentų skaičius	0
Programinės įrangos, kuria naudojantis sudarytas elektroninis dokumentas,	DocLogix v12.8.7.0

pavadinimas	
Informacija apie elektroninio dokumento ir elektroninio (-ių) parašo (-ų) tikrinimą (tikrinimo data)	Tikrinant dokumentą nenustatyta jokių klaidų, 2026-05-21 01:12:43

Melioracijos darbų kvalifikacijos atestatas

Rūšis Atestatas
Išduodanti institucija Lietuvos Respublikos žemės ūkio ministerija
Įm. k. 188675190
Vilnius, Gedimino pr. 19
Išduodanti institucija

Licencijos gavėjai Teisinė forma Mažoji bendrija
Pavadinimas MB "Gaprojektuotojas"
Kodas 304944719
El. paštas ga
Telefonas

	Kodas	Pavadinimas	Komentaras
Veiklos duomenys	2480	Melioracijos darbų kvalifikacijos veikla \ Melioracijos statinių projektavimas	

Numeris	315-Pm
Galioja nuo	2022-11-25
Galioja iki	2027-11-25
Būsena	Licencijos (leidimo) išdavimas
Atestavimo komisijos protokolo data	2022-11-25
Išdavimo data	2022-11-25
Atestavimo komisijos protokolo numeris	8D-516(5.50E)
Licencija archyvuota	

Melioracijos darbų kvalifikacijos atestatas

Rūšis Atestatas
Išduodanti institucija Lietuvos Respublikos žemės ūkio ministerija
Įm. k. 188675190
Vilnius, Gedimino pr. 19
Išduodanti institucija

Licencijos gavėjai Vardas ANDRIUS
Pavardė GEGUŽIS
Asmens kodas
Adresas
El. paštas
Telefonas

	Kodas	Pavadinimas	Komentaras
Veiklos duomenys	2484	Melioracijos darbų kvalifikacijos veikla \ Melioracijos statinių projekto vadovas	

Numeris	S-757-Pm
Galioja nuo	2023-04-06
Galioja iki	2028-03-30
Būsena	Licencijos (leidimo) patikslinimas
Atestavimo komisijos protokolo data	2023-03-30
Išdavimo data	2018-04-06
Atestavimo komisijos protokolo numeris	8D-153 (5,50E)
Licencija archyvuota	

KLASIFIKUOTI

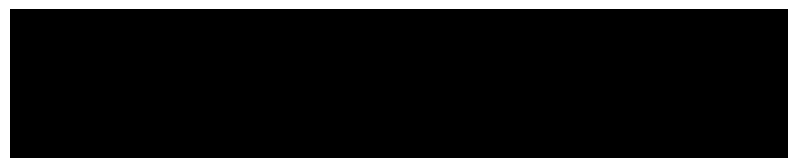

Informuojame, kad yra rengiamas projektas „Lazdijų r. sav. Avižienių, Krosnos, Šeštokų ir Teizų kadastrinių vietovių dalių melioracijos statinių rekonstrukcija“. Projektas apima Lazdijų r., Krosnos mstl., Avižienių gyv., Krosnėnų, Krasenkos, Naujavalkių, Saltininkų, Papečių, Kamenkos, Akuočių ir Straigių kaimų teritorijos ribas.

Projekto rengėjas – MB „Gaprojektuotojas“, tel. +370 695 09 627, el. p. gaprojektuotojas@gmail.com.

Užsakovas – Lazdijų rajono savivaldybės administracija, Vilniaus g. 1, Lazdijai.

Iškilius klausimams, prašome kreiptis į projektuotoją ar statytoją nurodytais kontaktais.